



**KAN-therm  
MULTISYSTEM**

**> 35** | years of experience  
on the installation  
market

# Guidebook

**SURFACE HEATING/COOLING**





























Install the **future**

EN 26/03

[kan-therm.com](http://kan-therm.com)



Complete multipurpose installation system consisting of modern, mutually complementary technical solutions for pipe water distribution, heating and cooling installations, as well as technological and fire extinguishing ones.

COLOUR SYSTEM							
							
SYSTEM NAME		ultra <b>LINE</b>	ultra <b>PRESS</b>	<b>PP</b>	<b>Steel</b>	<b>Inox</b>	<b>Copper</b>
DIAMETER RANGE [mm]		14-32	16-63	16-110	12-108	12-168,3	12-108
INSTALLATIONS TYPE							
	TAP WATER	●	●	●		●	●
	HEATING	●	●	●	●	●	●
	TECHNOLOGICAL HEAT	○	○	○	○	○	
	SOLAR				○	○	
	COOLING	○	○	○	○	●	●
	COMPRESSED AIR	○	○	○	○	○	○
	TECHNICAL GASES	○	○	○	○	○	○
	FLAMMABLE GAS						
	TECHNICAL OILS				○	○	○
	INDUSTRIAL				○	○	
	BALNEOLOGICAL			○		○	
	SPRINKLER FIRE-FIGHTING						
	HYDRANT FIRE-FIGHTING						
	UNDERFLOOR HEATING AND COOLING	●	●				
	WALL HEATING AND COOLING	●	●				
	CEILING HEATING AND COOLING	●	●				
	EXTERNAL SURFACES HEATING AND COOLING	●	●				

In untypical cases, it is necessary to check the conditions of using KAN-therm parts with technical and information materials or opinions of the KAN Technical Department. Use the form – Inquiry about the possibility to use KAN-therm elements – to send basic parameters of an installation operation. Based on the data sent, the Technical Department will assess the fitness of the system to the particular installation. The form can be found on the website.



**Surface heating and cooling**

**Cabinets, manifolds**

12-25      –

	○
●	●
	○
○	○
●	●
●	●
●	●
●	●

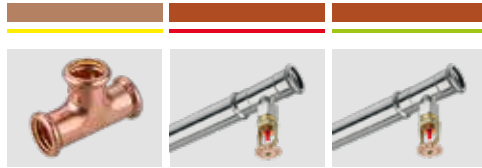

**Copper Gas**

**Steel XPress Sprinkler**

**Inox XPress Sprinkler**

15-54      22-108      22-108

		○
○	○	○
○	○	○
●		
	●	●
	●	●

● standard scope of application  
 ○ possible use – the conditions to be confirmed with the KAN Technical Department



## About KAN

### Modern water and heating solutions

KAN was established in 1990 and has been implementing state-of-the-art technologies in heating and water distribution solutions ever since.

KAN is European recognized leader and supplier of state-of-the-art KAN-therm solutions and installations intended for indoor hot and cold tap water installations, central heating and floor heating installations, as well as fire extinguishing and technological installations. Since the beginning of its activity, KAN has been building its leading position on such values as professionalism, innovativeness, quality and development. Today, the company employs over 1200 people, a great part of which are specialist engineers responsible for ensuring continuous development of the KAN-therm system, all technological processes applied and customer service. The qualifications and commitment of our personnel guarantees the highest quality of products manufactured in KAN factories.

KAN has a branch network in Poland and international offices around the world. The products with the label KAN-therm are exported to 65 countries on different continents. The distribution chain covers Europe and a significant part of Asia, Africa and America.

KAN-therm system is an optimal, complete multipurpose installation system consisting of state-of-the-art, mutually complementary technical solutions for pipe water distribution installations, heating installations, as well as technological and fire extinguishing installations. It is the materialization of a vision of a universal system, the fruit of extensive experience, the passion of KAN's constructors, as well as strict quality control of our materials and final products.

## INTRODUCTION

**KAN-therm system is a collection of ready-made, complete design solutions that enable implementation of indoor and outdoor water, surface heating and cooling installations.**

**It comprises modern, complementary solutions for installation materials and assembly techniques.**

The publication "KAN-therm MULTISYSTEM Guidebook Surface Heating/Cooling" is intended for all participants of the investment process, consisting in the construction of modern surface heating and cooling systems (floor, wall or ceiling) - designers, installers and supervision inspectors.

The guidebook is divided into chapters which present complete technical solutions and ready products and it also describes all aspects related to their design and assembly in:

- underfloor heating and cooling installations,
- wall heating and cooling installations.

The content of the manual complies with currently applicable national and EU standards as well as guidelines for surface heating and cooling systems, used in construction.

Designers using the traditional methods of dimensioning are welcomed to take advantage of a separate, attached to the Guidebook, set of tables containing hydraulic properties of pipes and fittings described in the Guidebook, with regard to typical parameters of surface installation operation.

**KAN manufacturing process, as any other KAN activity, is ISO 9001 certified.**

# Table of contents

<b>1</b>	General information	
1.1	Thermal comfort.....	9
1.2	Energy efficiency.....	10
1.3	Sources of heat and cold and supply temperatures for radiant systems.....	10
1.4	Application areas for KAN-therm surface heating and cooling systems.....	11
<b>2</b>	Underfloor heating and cooling in <b>KAN-therm</b> system	
2.1	Underfloor installations design.....	14
2.2	Heating loops arrangement.....	14
2.3	Dilatation in surface heatings.....	16
2.4	Heating and cooling screeds.....	19
2.5	Cement screed.....	20
2.6	Floor coverings in KAN-therm surface heating .....	22
<b>3</b>	<b>KAN-therm</b> underfloor heating and cooling systems	
3.1	KAN-therm Tacker system.....	24
3.2	KAN-therm Rail system .....	30
3.3	KAN-therm NET system.....	30
3.4	KAN-therm Profil system.....	31
3.5	KAN-therm TBS system.....	37
3.6	Monolithic constructions.....	42
3.7	Sports flooring heating in KAN-therm system.....	43
<b>4</b>	Wall heating and cooling with <b>KAN-therm</b> system	
4.1	General .....	48
4.2	Construction of the KAN-therm wall heating/cooling system.....	48
4.3	KAN-therm wall heating/cooling systems.....	50
4.4	"Dry" system, KAN-therm Wall gypsum-fibre boards.....	54

<b>5</b>	Components of <b>KAN-therm</b> radiant heating and cooling	
5.1	KAN-therm heating/cooling pipes	74
5.2	KAN-therm manifolds	78
5.3	KAN-therm installation cabinets	89
5.4	Pipe mounting systems in KAN-therm surface heating/cooling	92
5.5	Dilatation tapes and profiles	94
5.6	Other elements	95
<b>6</b>	<b>KAN-therm</b> automation controls	
6.1	General information	96
6.2	Adjustment and automation elements	97
<b>7</b>	Designing <b>KAN-therm</b> surface heaters	
7.1	Dimensioning of heating systems – assumptions	109
7.2	Hydraulic calculations for the installation, adjustments	115
7.3	Computer aided design KAN software packages	116
<b>8</b>	Acceptance forms	
8.1	Installation pressure test protocol	117
8.2	Screed heating protocol	120
8.3	Hydraulic adjustment execution protocol	121
<b>9</b>	Mollier graph	

Check the availability of KAN-therm products in the current catalogue.

The photographs presenting the offered goods are for reference only. Actual colour and design details of the elements may differ from those presented in the photographs.

When the new catalogue is released, the information contained in the earlier version of the catalogue will be updated.

KAN Sp. z o.o. reserves the right to supplement, change or replace commercial and technical information at any time.

© KAN Sp. z o.o. copyrights All rights reserved. Text, images, graphics and their layout in KAN Sp. z o.o. publications are covered by copyrights.

# 1 General information

The systems of low-temperature surface water heating and cooling (so-called hydronic systems) using floor, wall or ceiling surfaces as sources of heat or cold in rooms are becoming increasingly popular. The increase of energy prices forces the users to use modern heating or cooling installations which are at the same time inexpensive, made and operated in line with environmental protection requirements. Energy efficiency and comfort are the main reasons for choosing this method of room heating.

Thanks to the optimum temperature distribution, it is easier to maintain thermal comfort in the room, which translates into a reduction in the amount of energy supplied. The small difference in supply temperature compared to the ambient temperature of the installation also reduces transfer losses.

After only 2 years of operation, the investment costs associated with the construction of surface installation systems may be amortised.

This way, surface heating and cooling can be one of the cheaper ways of maintaining the thermal comfort in rooms.

Other advantages are equally important. Aesthetic value – such systems are invisible and allow for flexible interior design. They are also “clean” because reducing convection currents eliminates circulation and settling of dust. And last but not least, surface heating systems are reliable and durable, with heat source durability being the only constraint. The environmentally friendly value of such solutions should also be emphasised. They are powered by alternative heat sources (geothermal energy, solar energy, etc.). KAN-therm system offers a range of modern technologies that enable the construction of energy-efficient and sustainable water surface heating and cooling systems. It allows for the construction of any, even a very non-standard surface installation, including embedded in external surfaces. KAN-therm system is a complete solution – it contains all the elements (pipes, insulation, manifolds, cabinets, automation) necessary to assembly an efficient and cost-effective surface heating and cooling system.



## 1.1 Thermal comfort

Surface heating and cooling systems substantially improve perceived thermal comfort within indoor spaces. Their main advantage is that the majority of heat (or cold) is transferred by radiation, which makes it quite easy to maintain the so-called perceived temperature (the resultant of air, wall and floor temperature in a room), which determines the feeling of thermal comfort. The relation between the perceived temperature and building partition temperature as well as air temperature is shown on the Koenig chart.

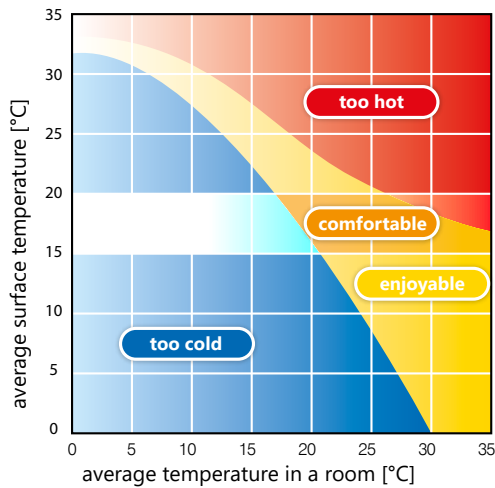

Surface heating/cooling systems are low-temperature designs.

The average temperature of the heating/cooling surface is only slightly higher (or lower in the case of cooling) than the air temperature in the room. The temperature of 20 °C in the room provides the same thermal comfort as 21-22 °C achieved with traditional, convection (heaters) or displacement (air-conditioning) heating and cooling installations.

Surface heating, in particular floor heating, as well as ceiling cooling, offers the most favourable, closest to ideal, indoor temperature distribution for humans. It means pleasant warmth for feet and favourable cooling at the head level.

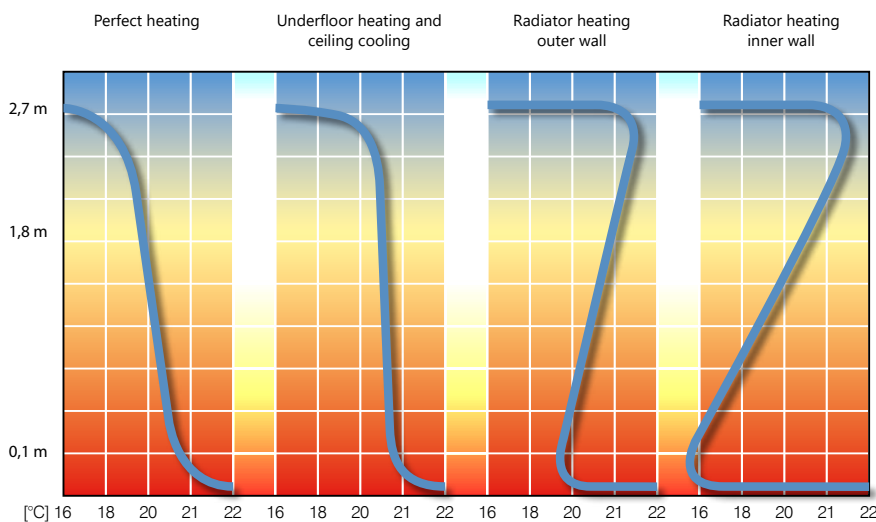

Fig. 1. Vertical temperature distribution for various types of heating.

The considerably reduced (compared with radiator heating systems or cooling by air-conditioning) air convection that makes allergenic dust float is important in terms of comfort within surface heating and cooling. Furthermore, the installation of this type reduces the growth of harmful mites due to the low relative humidity at the level of the thermally active partition. The surface solution, contrary to high-temperature radiator heating systems, does not cause excessive, harmful, positive air ionization.

## 1.2 Energy efficiency

Surface heating and cooling is a cost-effective system. The possibility of reducing (the heating mode) or increasing (the cooling mode) the indoor air temperature by 1-2 °C (compared to convection solutions), may result in heat energy savings range between 5-10 %, with no adverse effect on thermal comfort. The additional advantage of surface systems is the low temperature of supply water. This makes it possible to use cost-effective, unconventional heat sources such as solar collectors, heat pumps or condensing boilers. The surface installation gives heat uniformly in the area occupied by people. This feature is especially important in the case of heating high rooms. In the case of convection heating, warm air in such rooms gathers in the upper part and more energy must be used to maintain the temperature in the areas occupied by people. Surface systems are self-adjusting. This feature is due to the slight difference between the heating or cooling surface and indoor ambient temperature, at which heat exchange takes place. Any increase in the indoor air temperature (such as caused by heat gains) reduces the efficiency of surface heating (lower temperature difference), and the other way round, and therefore causes a counter-reaction to temperature maladjustment. With the constant flow of water in coils, it causes a reduction of the difference in supply and return water temperature, which translates into the increased energy efficiency of the heat or cold source that features automatic temperature control.

## 1.3 Sources of heat and cold and supply temperatures for radiant systems

Hydronic surface installations are low-temperature systems.

In the case of heating installations in line with EN 1264, the maximum temperature of heating water supply is 60 °C (for design external temperature) and the optimum temperature drop of water in the coils is 10 K (permissible range 5 ÷ 15 K).

In surface cooling installations in line with EN 1264, on the other hand, the minimum temperature of cooling water supply is the temperature resulting from the calculation of the water temperature increase at the level of 5 K (permissible range 5 ÷ 10 K) and the acceptable temperature of the cooling surface which can not be less than 6 K in relation to the air temperature in the room (protection against moisture condensation).

**Typical parameters of coil feed and return water are therefore:**

### **surface heating installations:**

- 55 °C/45 °C
- 50 °C/40 °C
- 45 °C/35 °C
- 40 °C/30 °C
- 35 °C/30 °C

### **surface cooling installations:**

- 22 °C/17 °C
- 20 °C/15 °C
- 17 °C/12 °C

In buildings in which the insulation of the building partitions meets the requirements of the latest technical specifications laid down in the regulation, the supply parameters of the surface installations oscillate at the level of the lowest (highest for cooling) temperatures. For this reason, the system power supply parameters must be determined in each case by the system designer on the basis of information about the construction of the building, as well as the type of system and the heat source.

Supply and return temperature for the entire system is determined for the room with the highest specific heat/cold demand. The installation can be supplied directly from low-temperature heat sources (condensation boilers, heat pumps) or, if combined with a radiator heating system, from the sources of higher temperature parameters, supplied from a system lowering the temperature of heating water (such as mixing systems) **Fig. 2** If the surface heating system is dominant in the building, the use of low-temperature heat sources may result in a significant reduction of operating costs.

In cooling installations, inverter heat pumps or waste cold from industrial or auxiliary equipment are most often used.

Energy savings result from the higher energy efficiency of these sources and lower heat losses of surface installations. The efficiency of the energy radiated into the room through such a system should not be less than 90 %.

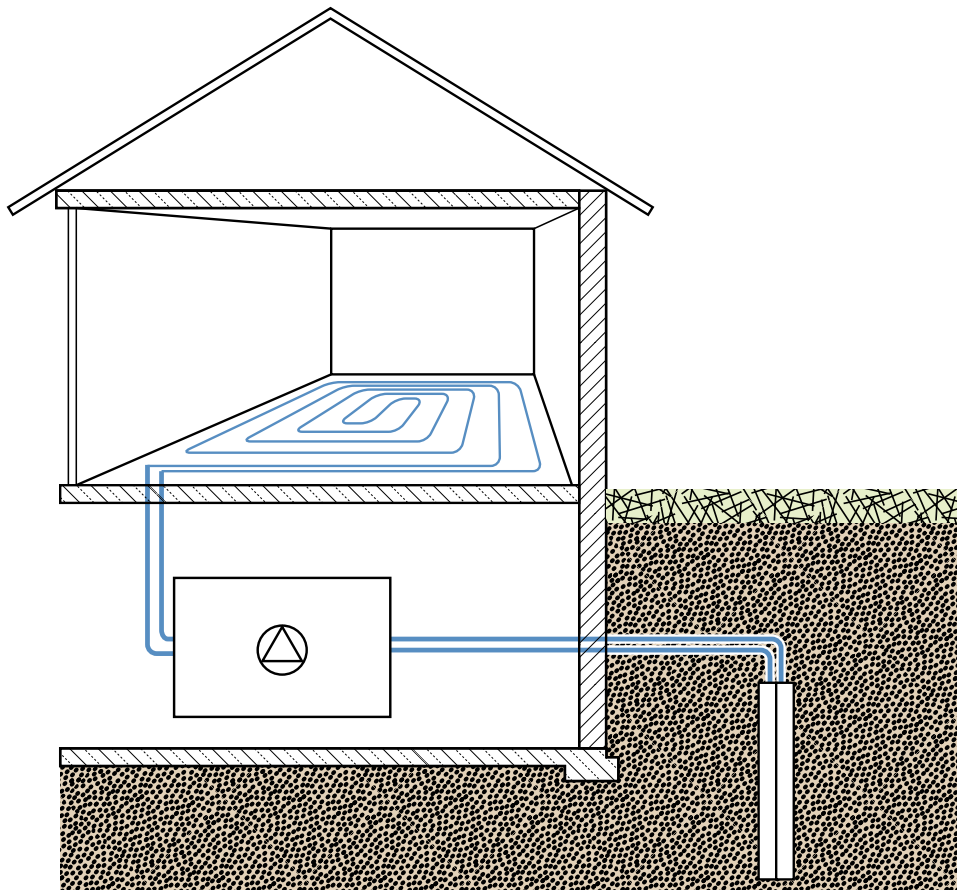

Fig. 2. Surface heating and cooling installation supplied directly from low-temperature heat source.

## 1.4 Application areas for KAN-therm surface heating and cooling systems

Water heating and cooling systems that use building partition surfaces (floors, walls, ceilings) are becoming increasingly popular, both in residential as well as general or industrial construction.

Due to the comfort and energy efficiency of this type of heating is chosen over other systems as source of heat (increasingly also cold) for houses and apartments.

Examples of an optimum use of surface heating systems are industrial or storage facilities as well as interior of church buildings – wherever high ceilings and large surface area rule out, for economic reasons, traditional heating systems. Surface heating systems are also equally well suited for objects that require a uniform temperature distribution – swimming pools, bathrooms, rehabilitation and sport sites.

Another category are heating systems for outdoor surfaces, heated using coils with medium heat warm, for example, pedestrian routes or playing field turf.



**Fig. 3.** Floor heating installation in single-family building, employing bluePERT pipes and KAN-therm Tacker system.



**Fig. 4.** Floor heating installation in industrial facility, employing bluePERT pipes and KAN-therm NET system.





**Fig. 5.** Heating installation of outdoor patio employing KAN-therm system bluePERT pipes.



Fig. 6. Ceiling cooling installation using heating and cooling panels of KAN-therm Wall system.

For all above areas of application KAN-therm system offers proven technical solutions such as insulation and pipe fastening systems as well as modern devices and automation.

SYSTEM KAN-therm					
Application areas	Tacker	Profil	Rail	TBS	NET
 FLOOR HEATING AND COOLING					
Residential housing, new objects	●	●	●	●	●
Residential housing, recovery		●		●	
General and public building construction	●	●	●	●	●
Historical buildings and places of worship	●	●	●	●	●
Sports facilities – floors with point elasticity	●	●	●		
Sports facilities – floors with surface elasticity	●		●		
Sports facilities – icerinks			●		●
Heating of industrial facilities	●		●		●
Industrial cooling storages			●		●
Monolithic constructions					●
 FLOOR HEATING AND COOLING OF OUTDOOR SURFACES					
Pedestrian routes, driveways			●		●
Green houses					●
Sports pitch			●		
Icerinks			●		

- Recommended for use
- Suitable for use in certain conditions

## 2 Underfloor heating and cooling in KAN-therm system

### 2.1 Underfloor installations design

#### Typical underfloor heating (or cooling) installation:

- thermal insulation layer situated directly at the ceiling structure (with or without damp-proof insulation),
- damp-proof layer that protects the insulation,
- heat distributing layer in a form of poured or dry screed,
- floor finishing layer.

Depending on the heating pipes arrangement, the EN 1264 standard distinguishes three (A, B, C) types of surface installation design.

KAN-therm system solutions generally cover A and B type.

#### For floor heating:

- Type A – pipes are located on the insulation or over the insulation placed inside the screed layer.
- Type B – pipes are located in the upper part of the thermal insulation layer.

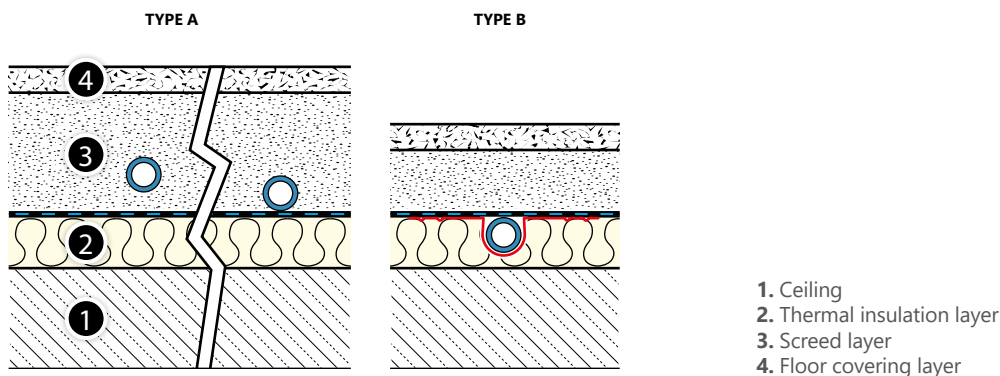

### 2.2 Heating loops arrangement

Pipes arrangement depends on the nature of the room (its purpose, shape), cooling partitions distribution (internal walls, windows), floor structure, as well as adopted pipes assembly technique. Two basic patterns are applied: spiral (**Fig. 7**) and series (**Fig. 8**).

Spiral pattern ensures the most even heating surface temperature distribution, because supply and return cables are arranged next to each other alternately. In the series pattern, the medium temperature is highest at the beginning of the coil, subsequent coil series temperature, due to the cooling, becomes increasingly lower, also the heating surface temperature decreases linearly. Therefore, the beginning of series pattern coil should be arranged near the partitions with the highest heat loss (external walls, windows, terraces).

The reverse is true for the cooling function using floor surface and loops laid out in series pattern.

The choice of coil arrangement does not have an impact on general thermal efficiency of the surface heater in a room, but it determines the temperature distribution on its surface.

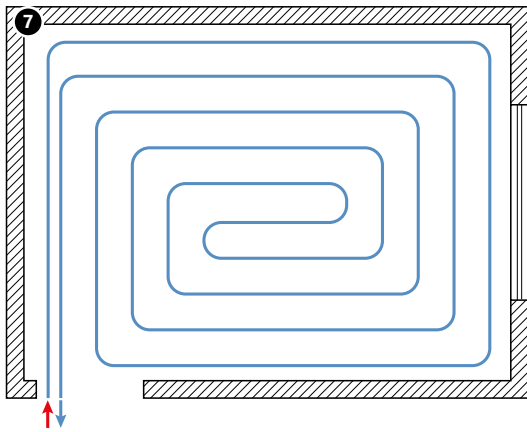

**Fig. 7.** Floor heating/cooling coil in spiral pattern.  
**Fig. 8.** Floor heating/cooling coil in series pattern.

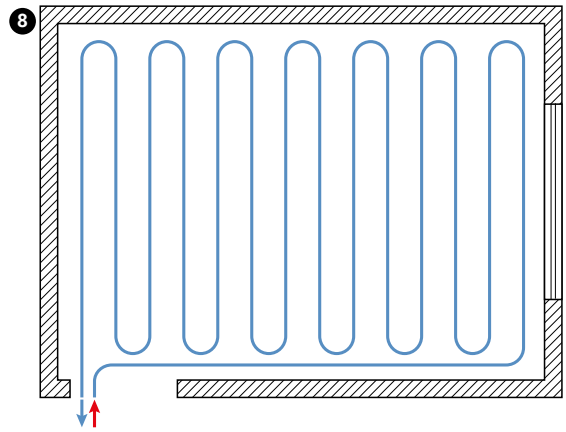

The combination of spiral and series patterns is also possible (**Fig. 9**), it ensures more balanced temperature distribution, which is suitable for areas of elongated shape.

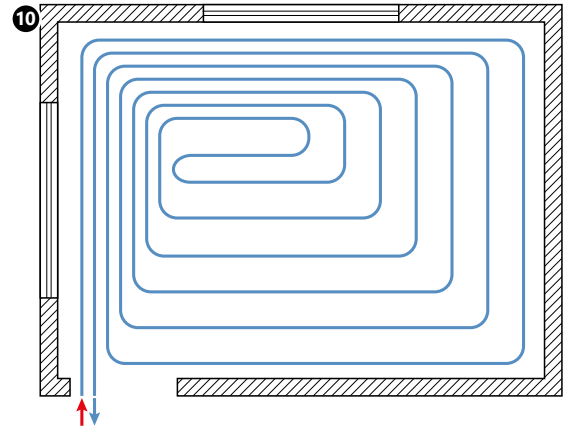
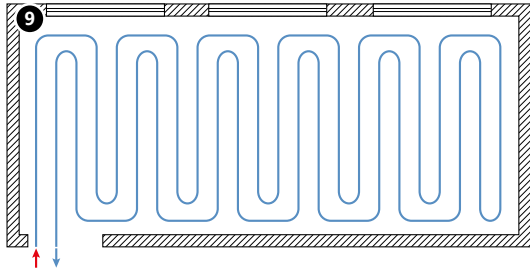

**Fig. 9.** Floor heating/cooling coil in mixed arrangement: double series pattern.  
**Fig. 10.** Floor heating/cooling coil in the spiral pattern, with an edge zone made on a single loop, arranged along the external walls or surfaces with large glazing.

If there are places with partitions of exceptionally high heat loss in the room, e.g. near large window and terrace openings, in their proximity, the loop spacing may be compacted by creating a peripheral zone (**Fig. 10**, **Fig. 11**, **Fig. 12**). The standard width of such a zone is 1 m, with permissible floor surface temperature of 31 °C for dry rooms and 35 °C for wet areas and bathrooms. The peripheral zone loops may be integrated with the standard loops of the heating field, as they have common power supply and return (**Fig. 10**, **Fig. 11**), they can also create a separate circuit (**Fig. 12**).

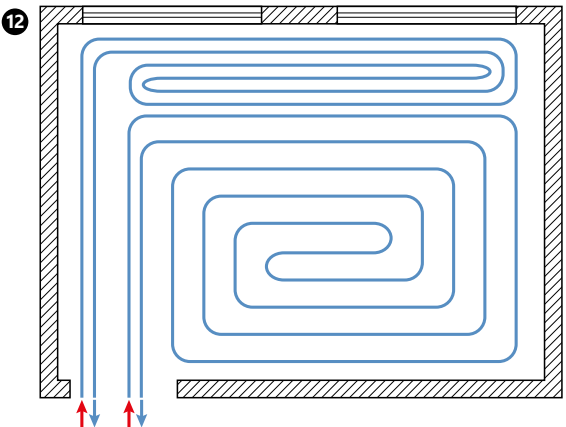
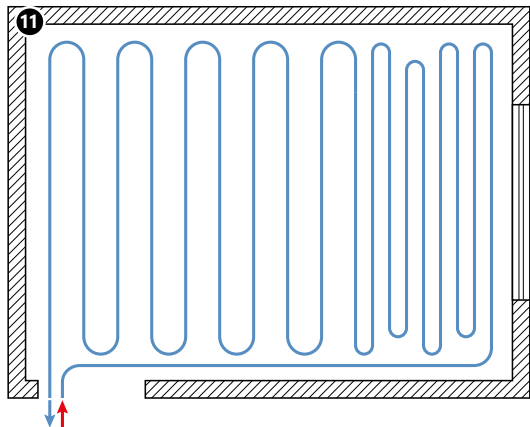

**Fig. 11.** Floor heating/cooling coil in the series pattern, with an edge zone made on a single loop, arranged along the external wall or surface with large glazing.  
**Fig. 12.** Floor heating/cooling coil in the spiral pattern, with an edge zone made on a separate loop, arranged along the external wall or surface with large glazing.

Coil heating pipes spacing is a significant parameter of a surface heater. It determines the size of thermal flux, which is radiated by a heating surface, it also has an effect on the evenness of heat distribution on the floor surface, as well as on the user's feeling of comfort.

Standard heating pipe spacing is 10, 15, 20, 25 and 30 cm. Larger spacing in typical applications is not used, due to the clearly perceived warmer and colder places on the floor surface. In the KAN-therm system, there are also non-standard spacings, which are the result of pipes mounting boards structure (16,7; 25 or 33,3 cm for TBS boards).

During loop arrangement (especially in the series pattern) with specified spacing, the pipes bending radius must be maintained. In case of small spacing, in order to maintain both spacing and required bending radius, the direction change arc should be "omega" letter shaped.

## 2.3 Dilatation in surface heatings

The dilatation solutions are applied in order to prevent the negative effects of thermal expansion of the heating pipes (floor, wall), which are subject to temperature changes. These include perimeter edge dilatations and dilatation gaps.

Insulations of perimeter dilatation, apart from the functions related to boards thermal motions, also serve as an acoustic and thermal insulation, which separates the boards from other perpendicular building partitions.

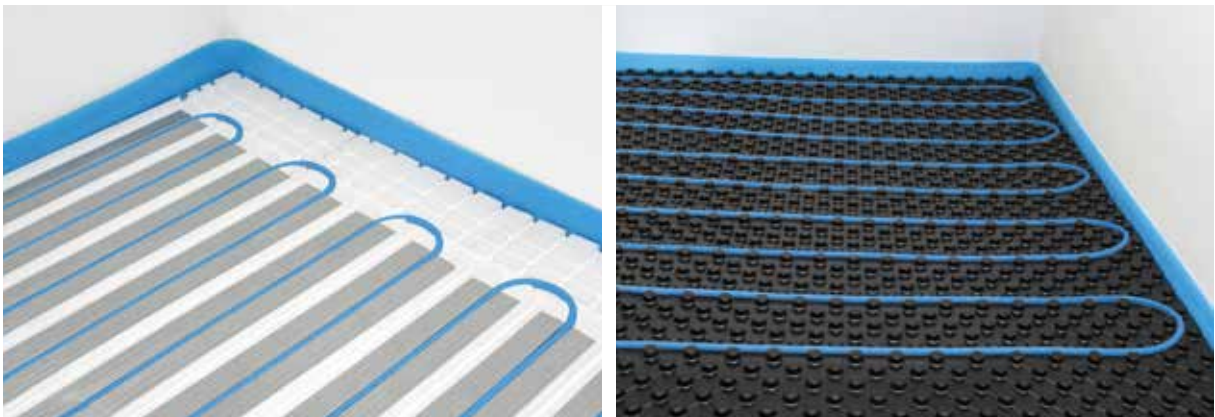

Fig. 13. Examples of edge insulation in KAN-therm floor heating.

All heating plate contact points with vertical building partitions should be separated by a perimeter dilatation (spacing of at least 5 mm must be maintained). Dilatation should also be performed along the entire length of the doorway thresholds.

KAN-therm wall tape made of 8 × 150 mm polyethylene foam with laid out on the thermal insulation PE foil apron, which protects against the ingress of screed, should be applied as an edge insulation. The tape should be arranged from the floor support substrate, to the over the planned upper level of the covering, and after performing the spout, it should be cut to the appropriate height (in case of elastic coverings, should be flushed with the spout).

**Heating plates distribution with dilatation gaps should be considered in the following cases:**

- the board surface exceeds 40 m<sup>2</sup>,
- board's sides length ratio is larger than 2:1,
- the length of one side exceeds 8 m,
- board's surface has a complex, other than rectangular shape (e.g. types L, Z etc.),
- heating plate is covered with various types of coverings.



Fig. 14. Distribution of heating fields with dilatation gaps

Heating plates distribution should be taken into account in the technical design.

A gap (of the minimum width of 5 mm) must separate the board's screed from the entire thickness of the adjacent board, starting from the thermal insulation up to the covering layer. To perform dilatation gaps, the KAN-therm dilatation profiles with feet, allowing to stick the tape to the insulation surface, are used.

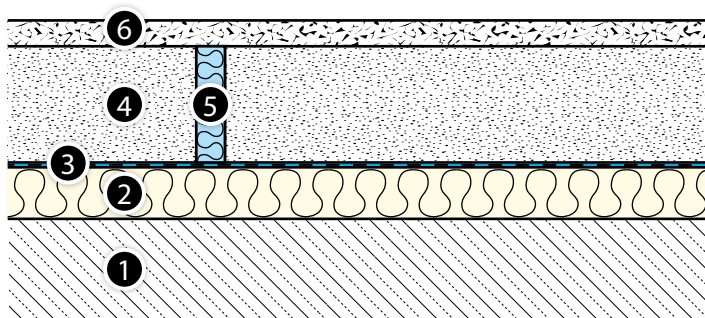

Fig. 15. Performance of dilatation gap in case of flooring made of soft covering.

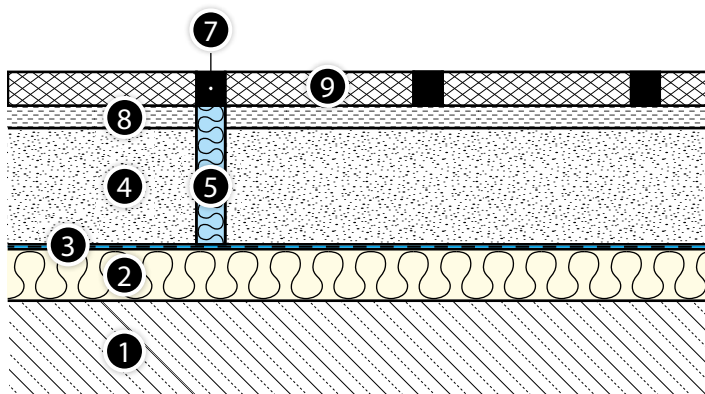

Fig. 16. Performance of dilatation gap in case of stone flooring.

1. Ceiling.
2. Thermal-acoustic insulation layer.
3. Protective foil.
4. Heating screed.
5. Dilatation gap.
6. Soft covering e.g. wooden.
7. Joint.
8. Adhesive mortar.
9. Stone flooring

In case of ceramic and stone boards, the distribution of heating plates should already be adjusted to their size and arrangement at the design stage, so that the joints between the boards were located directly above the dilatation gap. Joints in those places must be made of permanently flexible material, which is resistant to elevated temperatures.

Pipes forming the heating loops cannot pass through any dilatation. Transit pipelines that supply individual coils, which have to cross the dilatation gap, should be protected from damage by placing them inside special dilatation profiles, which are made of tape of foamed PE, profiled rail and casing pipes of 40 cm length (the endings of those pipes should be protected against ingress of liquid screed).

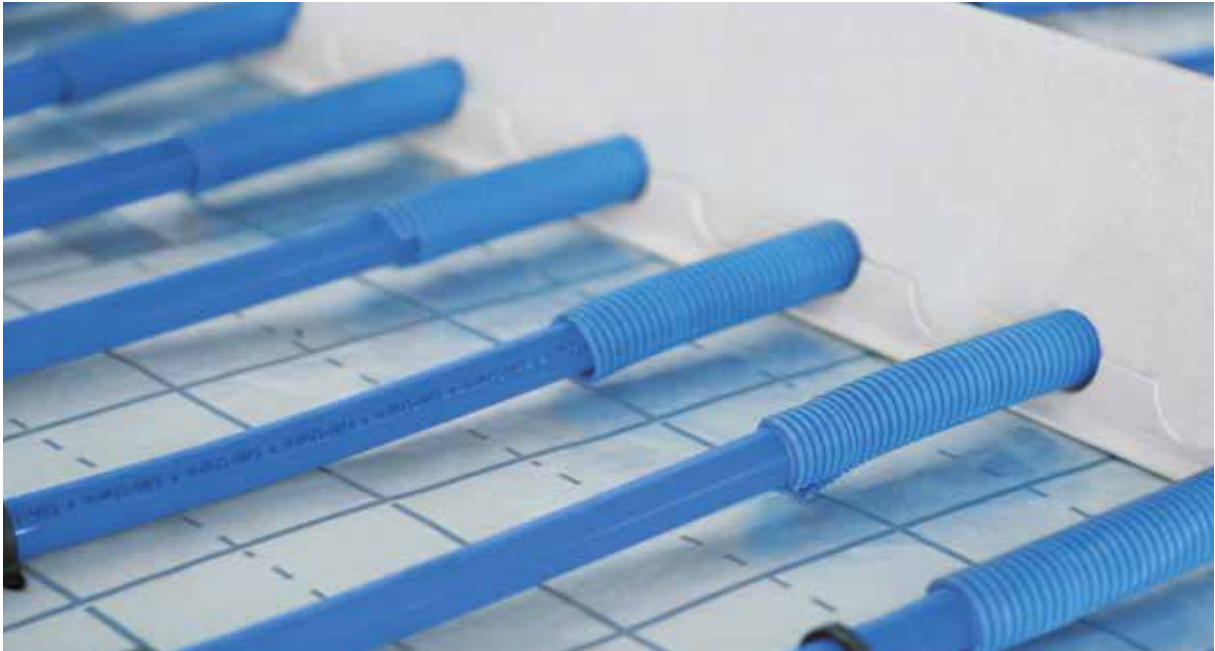

Fig. 17. Dilatation profile – way of transit pipes arrangement through dilatation.

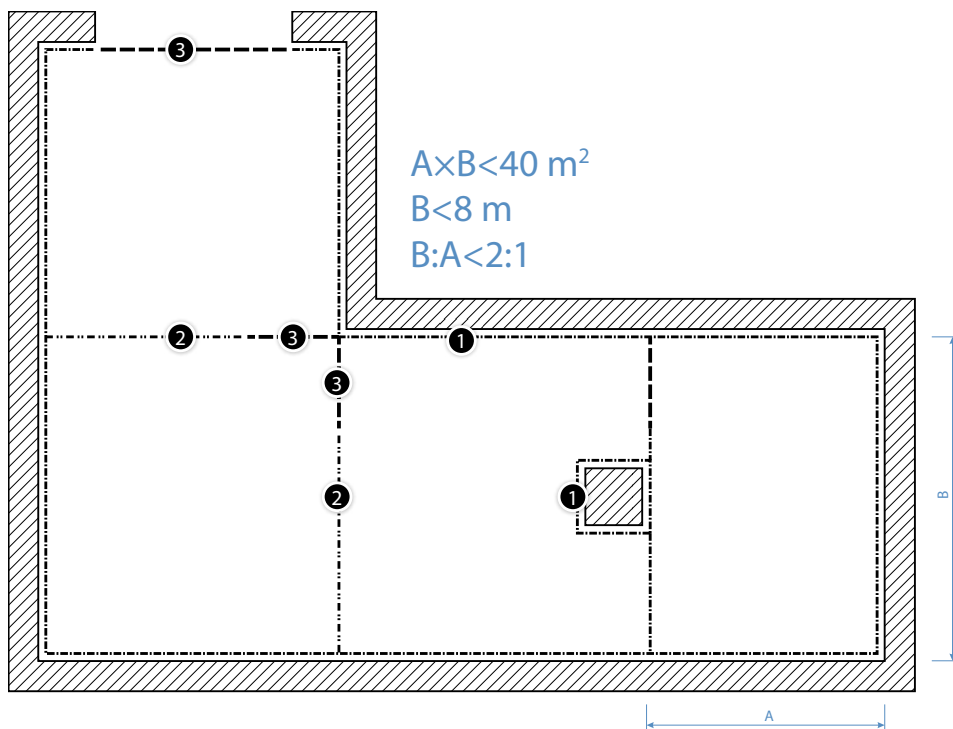

Fig. 18. Heating pipes dilatation in floor heating rules of performance.

1. Wall dilatations – wall tape (edge) with apron.
2. Boards dilatation – dilatation profile.
3. Dilatation joints for transition pipes.

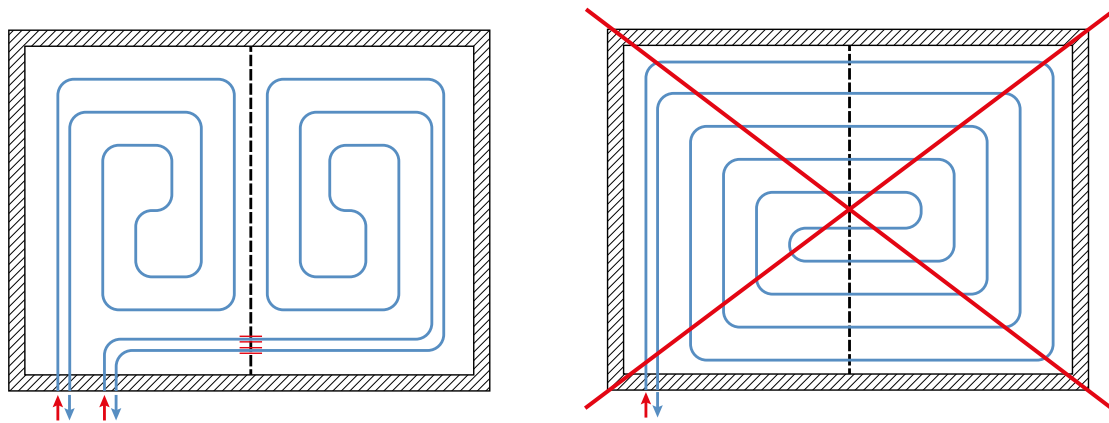

Fig. 19. Correct and incorrect distribution of heating field with a dilatation gap.

## 2.4 Heating and cooling screeds

### Screed has two functions in the surface heating/cooling:

- is a construction element that takes on the mechanical stress, being a result of permissible loads and stresses, arising from thermal expansions (both screed and pipes),
- serves as a layer that transfers heat or cooling to the room.

In the construction of floor heater type A (according to EN-PN 1264), performed using wet method, the screed is arranged in a plastic form (spout), based on cement or gypsum (anhydrite) mortar. In B type construction, the heating plate has a form of dry screed.

In both cases, the screed heating plate must be permanently separated from the building construction elements with a dilatation gap, forming the so called floating floor.

All types of screeds, used to perform flooring in the constructions, can be applied in floor heating. Regardless of the type of screed, every must have a proper thickness that guarantees the resistance to assumed mechanical loads, must feature low porosity and high thermal conductivity, as well as good plasticity during arrangement, which allows for a full contact of spout with heating pipes.

### Arrangement and screed curing general requirements:

- in order to protect laid pipes from damage, traffic routes should be designated, by laying out gangplanks (e.g. made of wood planks),
  - prior to the screed laying, perform coils pressure test, ended with an execution protocol and acceptance test (template **on page 117**),
  - during screed laying, maintain pressure in pipes of min 3 bars (6 bars recommended),
  - ensure that the room temperature is not lower than 5 °C,
  - protect against rapid change of environmental conditions (drafts, rain, sunlight),
  - ensure the conditions for performing proper heating pipes dilatation, in accordance with rules described above,
  - prior to the arrangement, ensure that the thermal insulation plates and dilatation protecting against liquid screed ingress are completely sealed,
  - heating plate cannot have contact with building construction elements,
- ensure correct conditions for maintenance and annealing of the plate, in accordance with guidelines and procedures set forth in "Screed heating protocol",
- prior to the covering arrangement check the humidity of the screed (see section: "Floor coverings" **on page 23**),
  - in objects other than residential, of higher flooring permissible load, the type and thickness of screed must be agreed with the constructor of the building.

## 2.5 Cement screed

The consistency of cement screed while laying should be plastic. Ambient temperature cannot be lower than 5 °C, and poured layer of screed should be seasoned for minimum 3 days in the minimum temperature of 5 °C. For the next 7 days, the screed should be protected against rapid change of environmental conditions (draft, sunlight) and not burdened with heavy items.

For typical in residential constructions cement screeds of parameters: compressive strength 20 N/mm<sup>2</sup> (class C20) and flexural strength 4 N/mm<sup>2</sup> (class F4), the spout thickness, counted from the top of a pipe, should be less than 45 mm (approx. 65 mm from the top of thermal insulation).

It is allowed to use ready-made screeds, which are capable of producing spout of lesser thickness, while maintaining the above mentioned strength parameters, due to the application of special supplements (chemical substances or fibers).

When using ready-made or custom spouts, refer to manufacturer's recommendations.

While individually preparing a cement-based screed spout, a BETOKAN modifying admixture should be added to the cement mortar, to improve its properties through:

- reducing the amount of mixing water,
- increasing the plasticity of the mixture,
- improving screed's hydrophobicity,
- reducing the contraction of concrete board,
- improving screed's thermal conductivity by approx. 20%,
- increasing the strength of prepared board,
- reducing corrosivity in relation to steel.



Fig. 20. BETOKAN and BETOKAN Plus modifying admixture.

Due to the application of BETOKAN Plus admixture, it is possible to reduce the screed's thickness to 2,5 cm over the top of pipes (4,5 cm from the top of thermal insulation).



### Note

Prior to the use of BETOKAN admixtures, read the terms of use and storage (on the packaging).



### Preparing a standard screed spout of total thickness of 6,5 cm, using BETOKAN admixture.

Use amount of 0,25–0,6% in relation to the mass of cement (on average 200 ml per 50 kg of cement) together with mixing water and aggregate.

#### **Composition of cement mortar:**

- CEM1 32.5 R cement (per EN 197–1:2011) – 50 kg,
- aggregate (60% sand of up to 4 mm granulation and 40% of gravel of 4–8 mm granulation) – 225 kg,
- 16–18 litres of water,
- BETOKAN 0,2 kg (~0,4% weight of cement).

#### **The sequence in which components should be added:**

- water (10 l) > BETOKAN (0,2 l) > aggregate (50 kg, approx. 30 l) > cement (50 kg) > aggregate (175 kg, approx. 110 l) > water (6–9 l).



#### **Preparing a standard screed spout of total thickness of 4,5 cm, using BETOKAN Plus admixture.**

When the board is 4,5 cm thick, the average consumption of BETOKAN Plus admixture is 10 kg per 7,5 m<sup>2</sup> of floor (30–35 kg per 1 m<sup>3</sup>) of concrete.

#### **Composition of cement mortar:**

- CEM1 32.5 R cement (per EN 197–1:2011) – 50 kg,
- aggregate (60% sand of up to 4 mm granulation and 40% of gravel of 4–8 mm granulation) – 225 kg,
- 8–10 litres of water,
- BETOKAN Plus 5 kg (~10% weight of cement).

#### **The sequence in which components should be added:**

- aggregate (50 kg approx. 30 l) > cement (50 kg) > water (8 l) > BETOKAN Plus (5 kg) > aggregate (175 kg, approx. 110 l) > water (until consistency becomes plastic)

The curing period for a cement screed is usually between 21 and 28 days, and the underfloor heating system may only be switched on once this period has elapsed. The screed is preheated at a heating medium temperature of approximately 20 °C for 3 days, followed by operation at the system's maximum working temperature for a further 4 days. After this stage, ceramic and stone tiles may be laid, provided the screed does not exhibit excessive moisture.

If the planned finish (e.g. laminate flooring, parquet or other wooden floor coverings) requires the subfloor to have a lower moisture content, it is necessary to carry out a process to dry out the screed. This process can be started 28 days after the screed has been laid, by setting the medium temperature to approximately 25 °C and then increasing it by approximately 10 °C every 24 hours until a maximum temperature of 55 °C is reached. This temperature should be maintained until the required moisture content in the screed is achieved.

Simply carrying out the curing process does not guarantee that the correct moisture content has been achieved; therefore, it is essential to measure the moisture content before commencing any flooring work. For wooden floor coverings and moisture-sensitive materials, the measurement must be carried out using the CM method. The permissible moisture content of the screed after curing should not exceed 1.8% CM for cement screeds and 0.3% CM for anhydrite screeds, unless the flooring manufacturer specifies more restrictive values. In the case of ceramic tiles, an additional test may be carried out using a PE film with an area of approximately 1 m<sup>2</sup>, tightly

Seasoning and annealing of screed should be performed in accordance with the procedure set forth in "Screed annealing and maintenance protocol".

### **Anhydrite screed (gypsum)**

Anhydrite screed usually has a liquid consistency. During arrangement, the ambient temperature cannot be lower than 5 °C, and poured layer of screed should be seasoned for minimum 2 days in the minimum temperature of 5 °C. For the next 5 days, the screed should be protected against rapid change of environmental conditions (draft, sunlight) and not burdened with heavy items.

Gypsum screeds are sensitive to humidity, the spouts should be protected against it both during the seasoning and exploitation.

The arrangement and maintaining procedure of anhydrite screed should be performed strictly in accordance with mixture manufacturer's recommendations.

## Screed reinforcement

In typical applications (e.g. in residential construction) the reinforcement of floor screed layer is not necessary.

If higher permissible loads are expected, the screed of higher strength class should be applied (while also taking into account the thermal insulation mechanical properties).

The application of reinforcement in surface heating spouts does not significantly impact strength of the floor, it can, however, limit the contraction joints dimensions. Suitable fibers added to the mixture or fiberglass mesh or steel wire may be applied for screed reinforcement. KAN offers a convenient fiberglass mesh of 13 × 13 mm grid. The mesh should be arranged over the pipes in the upper part of screed layer. Reinforcement made by mesh must be interrupted at the dilatation gaps zone.

## 2.6 Floor coverings in KAN-therm surface heating

In the KAN-therm surface heating/cooling system various types of floor coverings may be applied. But, due to their significant influence on surface heater thermal efficiency, the materials of low thermal resistance are preferred. It is assumed that this value (for covering and bonding layer) should not exceed  $R = 0,15 \text{ m}^2 \times \text{K/W}$ .

If at the design stage it is impossible to determine the type of covering, the value  $R = 0,10 \text{ m}^2 \times \text{K/W}$  can be adopted for calculations.

Floor heating design must take into account the type of covering on the heating plate, as this layer determines the transfer of heat to the room and influences the temperature of floor surface.

Thermal efficiency for individual KAN-therm surface heating systems, which takes into account the thermal resistance of coverings, are provided in separate charts, attached to the handbook.

Tab. 1. Exemplary, indicative values of thermal conductivity resistances of various floor coverings materials

Floor covering material	Heat conductivity $\lambda$ [W/m × K]	Thickness [mm]	Heat conductivity resistance $R_{\lambda B}$ [m <sup>2</sup> K/W]
Ceramic tiles	1,05	6	0,0057
Marble	2,1	12	0,0057
Plates made of natural stone	1,2	12	0,010
Carpets	–	–	0,07 – 0,17
PVC floor lining	0,20	2,0	0,010
Mosaic parquet (oak)	0,21	8,0	0,038
Plank parquet (oak)	0,21	16,0	0,076
Laminate	0,17	9	0,053

For calculations, with sufficient precision, the following values of thermal resistance may be adopted (taking into account the bonding layer)  $R_{\lambda B}$  [m<sup>2</sup> K/W]:

- ceramics, stone: 0,02,
- PVC coverings: 0,05,
- parquet of thickness up to 10 mm, carpet of thickness up to 6 mm: 0,10,
- parquet of thickness up to 15 mm, carpet of thickness up to 10 mm, floor panel with underlay: 0,15.

## General requirements

All types of floor coverings and glues applied for laying those coverings of heating plates, cannot radiate harmful substances at elevated temperatures, for this reason they should have labelling, which authorise their use in floor heating. Those materials, especially glues, are exposed to high temperatures, which exceed 40 °C at the level of glue layer.



Fig. 21. Example of materials applied in floor heating labelling.

All coatings, and especially flexible plastic coverings, should be precisely glued on the whole surface, without bubbles, which unnecessarily increases covering's thermal resistance.

It is possible to lay coverings not bonded with the substrate (e.g. floor panels), but only if special floor heating substrates are applied.

Laying of external floor layer can be performed after pre-annealing of screed, at the flooring temperature of 18–20 °C. Prior to the arrangement the humidity of the substrate should be verified. Maximum moisture content in heating screeds prior to the floor covering laying is presented in the table below. Moisture measurements should be carried out in accordance with the guidelines set out in the section 'Cement screed'. Laying of floor coverings should be performed in accordance with flooring manufacturer's recommendations.

## Ceramic and stone coverings

Glue mortars and joints, due to the differences in covering and substrate elongation, must have proper durability and elasticity. Boards joints should overlap dilatation gaps of heating fields.

## Carpets

Carpets require higher supply temperatures. If they have the manufacturer's certification, they can be applied in floor heating. They should be stuck to the substrate along the whole surface.

## Wooden coverings

The humidity of parquet or mosaic during laying cannot be higher than 8–9%. The parquet should be laid on the screed of temperature in the range of 15–18 °C. The recommended maximum operation temperature of surface is 29 °C, avoid laying parquet on thickened edge zones.

Tab. 2. Maximum permissible moisture content in heating screeds [%]

Type of floor covering	Cement screed	Anhydrite screed
Textile and elastic coverings	1,8	0,3
Wooden parquet	1,8	0,3
Laminated floors	1,8	0,3
Ceramic tiles or natural stone and concrete products	2,0	0,3

The floor covering substrate humidity should be measured in at least 3 places per room (or per each area of up to 200 m<sup>2</sup>).

## 3 KAN-therm underfloor heating and cooling systems

### 3.1 KAN-therm Tacker system

The design of radiant heating composed of KAN-therm Tacker boards is classified (according to EN 1264 standard nomenclature) as type A, performed using the wet method. Pipes should be fixed to the insulation with plastic clips, using a special tool, so called Tacker (KAN-therm Tacker system), and then covered with liquid screed. After binding period, followed by annealing, the floor is laid on the screed.



#### Application

Floor heating (or cooling) in residential and general construction.

#### Advantages

- quick assembly using the Tacker tool,
- wide variety of thermal insulation boards,
- the possibility of mounting pipes with any spacing and in various configurations (series pattern and spiral pattern),
- manual and mechanical heating pipes mounting,
- the possibility of application for floors exposed to considerable permissible loads.

Tab. 1. KAN-therm thermal insulations in underfloor heating/cooling

Insulation thickness [mm]	KAN-therm Tacker		
	EPS 100		
	20	30	50
Useful dimensions width × length [mm]	1 000 × 10 000	1 000 × 10 000	1 000 × 5 000
Usable area [m <sup>2</sup> /roll]	10	10	5
Thermal conductivity coefficient $\lambda$ [W/(m × K)]	0,038	0,038	0,038
Thermal resistance $R_{\lambda}$ [m <sup>2</sup> K/W]	0,53	0,79	1,32
Sound attenuation dB	—	—	—
Max load kg/m <sup>2</sup> (kN/m <sup>2</sup> )	3000 (30)	3000 (30)	3000 (30)

Tab. 2. KAN-therm Tacker system – minimum requirement for insulation thickness according to PN-EN 1264

System insulation A thickness	Supplementary insulation B thickness	Total insulation resistance $R [m^2K/W]$	Total insulation thickness C [mm]
<b>Required insulation thickness above the heated room <math>R_{\lambda}=0,75 [m^2K/W]</math> (Fig. 22 or Fig. 23)</b>			
Tacker EPS100 30 mm	—	0,79	30
Tacker EPS100 20 mm	styrofoam EPS100 20 mm	1,06	40
<b>Required insulation thickness above the room heated to lower temperature, as well as above the room, which is not heated or a room placed on the ground <math>R_{\lambda}=1,25 [m^2K/W]</math> (Fig. 23 or Fig. 24)</b>			
Tacker EPS100 50 mm	—	1,32	50
Tacker EPS100 30 mm	styrofoam EPS100 20 mm	1,32	50
Tacker EPS100 20 mm	styrofoam EPS100 40 mm	1,58	60
<b>Required insulation thickness for floor in contact with the outside air (<math>T_z \geq 0 \text{ }^\circ\text{C}</math>) <math>R_{\lambda}=1,25 [m^2K/W]</math> (Fig. 23)</b>			
Tacker EPS100 50 mm	—	1,32	50
Tacker EPS100 30 mm	styrofoam EPS100 20 mm	1,32	50
Tacker EPS100 20 mm	styrofoam EPS100 40 mm	1,58	60
<b>Required insulation thickness for floor in contact with the outside air (<math>0 \text{ }^\circ\text{C} &gt; T_z \geq -5 \text{ }^\circ\text{C}</math>) <math>R_{\lambda}=1,50 [m^2K/W]</math> (Fig. 23)</b>			
Tacker EPS100 50 mm	—	1,32	50
Tacker EPS100 30 mm	styrofoam EPS100 20 mm	1,32	50
Tacker EPS100 20 mm	styrofoam EPS100 40 mm	1,58	60
<b>Required insulation thickness for floor in contact with the outside air (<math>-5 \text{ }^\circ\text{C} \geq T_z \geq -15 \text{ }^\circ\text{C}</math>) <math>R_{\lambda}=2,00 [m^2K/W]</math> (Fig. 23)</b>			
Tacker EPS100 50 mm	styrofoam EPS100 30 mm	2,11	80
Tacker EPS100 30 mm	styrofoam EPS100 50 mm	2,11	80
Tacker EPS100 20 mm	styrofoam EPS100 70 mm	2,37	90



### Note

EN 1264 provides minimum requirements for thermal insulation thickness. In addition it is based on ambient temperature range  $-5 \text{ }^\circ\text{C} \geq T_z \geq -15 \text{ }^\circ\text{C}$ , while for the climate conditions in some of regions, ambient temperature may falls within different range.

Therefore, in order to ensure energy efficiency conditions, standard requirements or other national guidance must be extrapolated.

## Elements of KAN-therm Tacker system floor heater

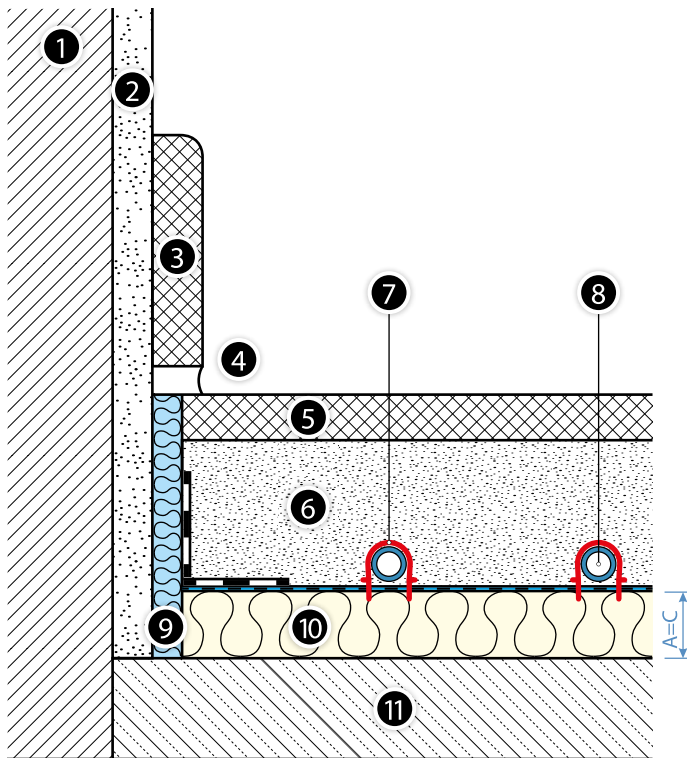

**Fig. 22.** Floor heater with KAN-therm Tacker system board on the ceiling above an internal room.

1. Wall.
2. Plaster layer.
3. Baseboard.
4. Armor joint.
5. Floor lining.
6. Screed.
7. Pipe clip.
8. KAN-therm heating pipe.
9. Wall tape with PE protective apron.
10. KAN-therm Tacker system board of thickness A with raster foil.
11. Concrete ceiling.

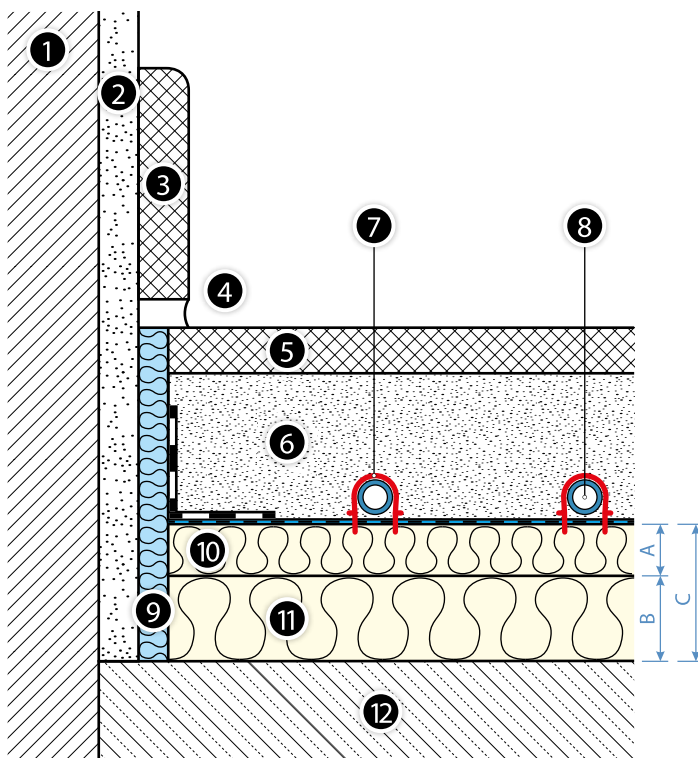

**Fig. 23.** Floor heater with KAN-therm Tacker system board and supplementary insulation on the ceiling above internal not heated room and on the ceiling in contact with outside air.

1. Wall.
2. Plaster layer.
3. Baseboard.
4. Armor joint.
5. Floor lining.
6. Screed.
7. Pipe clip.
8. KAN-therm pipe.
9. Wall tape with PE protective apron.
10. KAN-therm Tacker system board of thickness A with raster foil.
11. Supplementary board of thickness B.
12. Concrete ceiling.

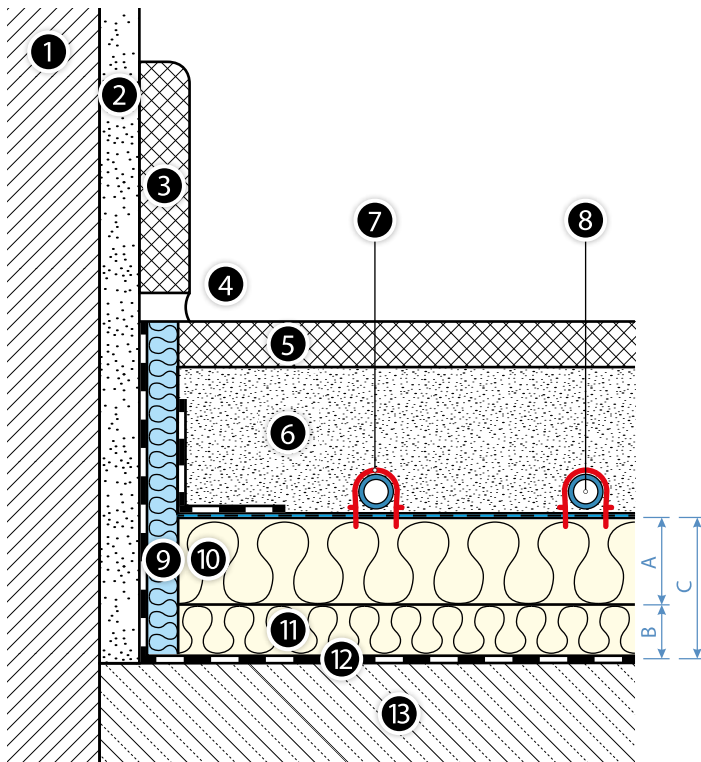

**Fig. 24.** Floor heater with KAN-therm Tacker system board and supplementary insulation and damp-proof coating on the ceiling laid out on the ground.

1. Wall.
2. Plaster layer.
3. Baseboard.
4. Armor joint.
5. Floor lining.
6. Screed.
7. Pipe clip.
8. KAN-therm pipe.
9. Wall tape with PE protective apron.
10. KAN-therm Tacker system board of thickness A with raster foil.
11. Supplementary board of thickness B.
12. Damp insulation (only at the ground!).
13. Concrete ceiling.

- wall tape of foamed PE, with foil apron, dimensions 8 × 150 mm,
- styrofoam board with KAN-therm Tacker EPS 100 metallised, laminated foil or polypropylene fabric (20, 30 and 50 mm thickness),
- additional thermal insulation in the form of ESP100 styrofoam boards of 20, 30, 40 and 50 mm thickness,
- clips for mounting pipes of 14–20 mm diameter,
- adhesive tape,
- KAN-therm system PEXC, PERT, PERT<sup>2</sup> and bluePERT pipes with EVOH layer of 16 × 2, 16 × 2,2, 18 × 2, 20 × 2 and 20 × 2,8 diameter or KAN-therm system PERTAL, PERTAL<sup>2</sup> and bluePERTAL pipes with aluminum layer of 14 × 2, 16 × 2, 16 × 2,2, 20 × 2, 20 × 2,8 diameter,
- screed BETOKAN additive.

**Tab. 3. Approximate unit consumption of materials [quantity/m<sup>2</sup>]**

Item designation	unit	The amounts at pipe spacing [cm]				
		10	15	20	25	30
<b>KAN-therm pipes</b>	m	10	6,3	5	4	3,3
<b>Pipe clip</b>	unit	17	12	11	9	8
<b>Adhesive tape</b>	m	1	1	1	1	1
<b>Tacker system insulation</b>	m <sup>2</sup>	1	1	1	1	1
<b>Supplementary insulation (if present)</b>	m <sup>2</sup>	1	1	1	1	1
<b>Wall tape 8 × 150 mm</b>	m	1,2	1,2	1,2	1,2	1,2
<b>BETOKAN supplement (at 6,5 cm screed)</b>	kg	0,2	0,2	0,2	0,2	0,2



**Tables for thermal calculation of floor heating and cooling performed in KAN-therm Tacker system are provided in separate charts, attached to this handbook.**



Fig. 25. KAN-therm Tacker system floor heating/cooling.

## Assembly guidelines

### General requirements

Laying of floor heating/cooling should be preceded by window and door frames mounting and completion of plastering. Works should be performed in the temperature above +5 °C. If the floor is laid on the surface laying on the ground, the damp insulation should be executed prior to the laying of acoustic and thermal insulation.

The surface must be dry, clear, flat and even, in order to lay the system boards. Impurities should be removed and the discrepancy of levels compensated if necessary (with filler or levelling mortar). The acceptable tolerance of the support substrate unevenness for the floor heating installation is:

Distance between measuring points [m]	Surface unevenness [mm]	
	Wet system	Dry system
0,1	5	2
1	8	4
4	12	10
10	15	12
15	20	15

## Assembly stages



1. Assembly the installation cabinet and manifold. Expand the wall tape with a plastic apron along the walls, columns, frames, etc.
2. If required, lay the acoustic insulation or additional thermal insulation on the whole surface. Start the assembly of KAN-therm Tacker thermal insulation with metallised or laminated foil along the wall.

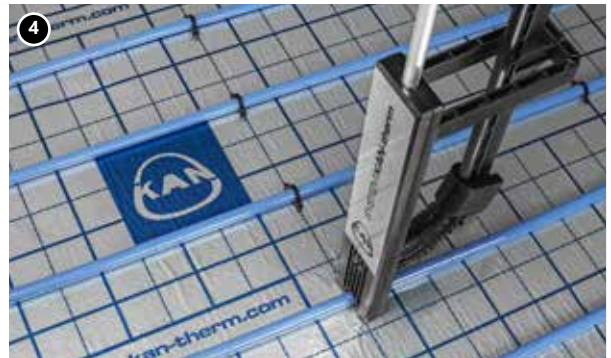

3. Subsequent strips on insulation should be laid about expounding the protruding tabs of foil on adjacent plates. The adjacent insulation strips must be consistent with the grid lines. Contact points of all edges must be sealed with an adhesive tape as the laying of subsequent strips progresses.  
The surfaces in cavities, frames should be complemented with the unused portions of the thermal insulation (while sealing the contact edges with a tape). Lay the PE foil apron fixed to the wall tape on the Tacker boards and seal it with an adhesive tape.
4. Proceed to the laying of pipes on the insulation, starting from the manifold. The assembly must be performed by two people. Pipes can be laid in any configuration (series pattern and spiral pattern) with a spacing of 10–30 cm and increment of 5 cm, using the printing on the foil, in order to arrange them evenly. While changing direction be aware of the permissible bending radius of the pipe.  
Pipes are mounted to the insulation with plastic clips either manually or by using the tool – Tacker, which significantly quickens the work.  
Pipes on the approach to the manifold must be arranged in plastic curves. To avoid the overheating of screed at pipes congestion (close to the manifold), arrange them in casing pipes or thermal insulation.  
If the partition of hotplates with dilatation is necessary, a dilatation profile with an adhesive flange should be mounted at the line of separation. The transit pipes passing through the profile should be arranged in protective sleeves of approximate length of 40 cm.

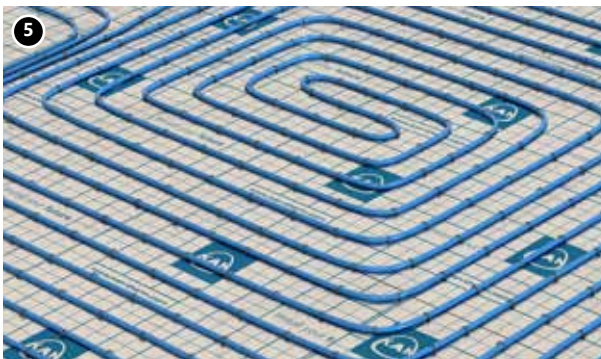

5. Perform a pressure test of arranged coils leakage in accordance with the rules applicable for the surface heating (see section Acceptance forms). After the test, leave the pipes under pressure (min 3 bars).

Cover the surface with arranged pipes with screed of thickness and parameters provided in the project. After screed binding proceed to screed curing (annealing) in accordance with the procedure described in the Acceptance forms section, and then, after verifying the humidity of the screed, begin the arrangement of floor lining.

### 3.2 KAN-therm Rail system

In case of heating/cooling board performance with wet method (type A), the only difference between the KAN-therm Rail system and the KAN-therm Tacker system is the method of attaching pipes to the thermal insulation. Pipes are arranged on the thermal insulation in Rail plastic rails, mounted to the insulation by means of metal pins, dowels or adhesive tape.

**The KAN-therm Rail pipe assembly system is also applicable in:**

- the constructions of underfloor heating and cooling performed using dry method with an air gap, for example floor heating systems laid on joists. See section "Sports floor heating in KAN-therm system",
- outdoor surfaces heating/cooling systems, for example turf of playing fields or ice rink plate (strips for pipes of 18, 20 and 25 mm diameter).

**! System elements – section "Pipe assembly systems in KAN-therm surface heating/cooling"**



### 3.3 KAN-therm NET system



KAN-therm NET is a system of heating pipes mounting on various types of surfaces (on thermal insulation, on the ground, on concrete base). The design of heating (or cooling) installation may differ depending on the applied thermal insulation (or lack thereof) and on the type and thickness of layers over the pipes.

Pipes are mounted on the laid on the insulation mat (grid), made of 3 mm wire with a mesh of 150 × 150 mm, using plastic bands or holders (clips) placed on the grid.

The wire grid can be arranged on the KAN-therm Tacker system styrofoam boards or standard EPS styrofoam boards with an unfolded PE damp-proof foil, fixed to the boards by means of plastic dowels. KAN-therm NET system may be applied for mounting of pipes in the monolithic constructions, for example thermo-active ceilings, and for arranging pipes in the outdoor surface heating systems, for example traffic routes.

**! Elements of the system are presented in section "Pipe assembly systems in KAN-therm surface heating/cooling"**

### 3.4 KAN-therm Profil system

The construction of surface heater composed of KAN-therm Profil system boards may be classified as type A, performed using wet method, according to the EN 1264 standard nomenclature. Pipes are placed, by pressing, between special tabs, profiled on the thermal insulation (styrofoam).



#### Application

Floor heating and cooling in residential and general construction.

#### Advantages

- fast assembly due to easy fixing of heating pipes, as well as simple system boards arrangement,
- lesser consumption of screed,
- the possibility of mounting pipes with any spacing and in various configurations (series pattern and spiral pattern),
- secure mounting of pipes,
- the possibility of application in floors exposed to considerable permissible loads.

Tab. 4. Thermal insulation technical specifications

Thickness [mm]	KAN-therm Profil system			
	Profil2 EPS 200 with PS foil	Profil4 EPS 200 without foil	Profil3 only profiled PS foil	Profil1 EPS T-24 with PS foil
	11	20	1	30-2
Overall thickness [mm]	32	47	20	51
Dimensions width × length [mm]	850 × 1450	1120 × 720	850 × 1450	850 × 1450
Useful dimensions width × length [mm]	800 × 1400	1100 × 700	800 × 1400	800 × 1400
Usable area [m <sup>2</sup> /board]	1,12	0,77	1,12	1,12
Thermal conductivity coefficient λ [W/(m × K)]	0,036	0,036	—	0,040
Thermal resistance R <sub>λ</sub> [m <sup>2</sup> K/W]	0,31	0,56	—	0,75
Sound attenuation dB	—	—	—	28
Max load kg/m <sup>2</sup> (kN/m <sup>2</sup> ) option	6000 (60)	6000 (60)	—	500 (5)

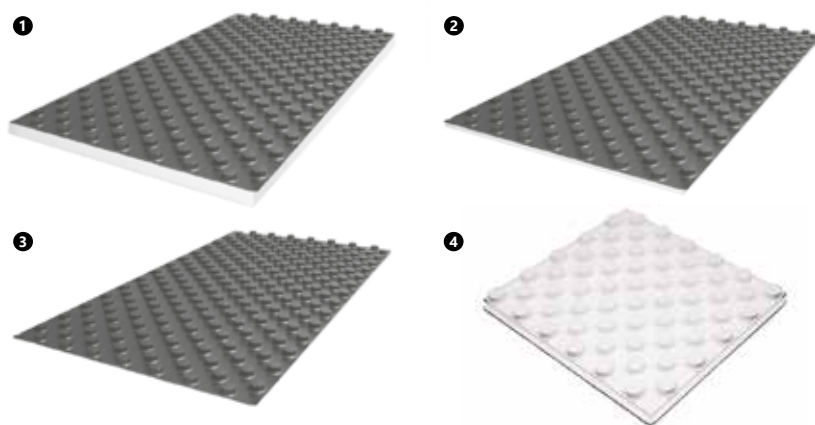

1. Profil1
2. Profil2
3. Profil3
4. Profil4

Tab. 5. KAN-therm Profil system – minimum requirement for insulation thickness according to EN 1264

System insulation A/Ac* thickness	Supplementary insulation B thickness	Total insulation resistance R[m <sup>2</sup> K/W]	Total insulation thickness C [mm]
<b>Required insulation thickness above the heated room <math>R_{\lambda}=0,75</math> [m<sup>2</sup>K/W] (Fig. 26 or Fig. 27)</b>			
Profil1 30/50 mm	—	0,75	30
Profil2 11/31 mm	styrofoam EPS100 20 mm	0,84	31
Profil4 20/47 mm	styrofoam EPS200 20 mm	1,09	40
Profil3 0/20	styrofoam EPS100 30 mm	0,79	30
<b>Required insulation thickness above the room heated to lower temperature, as well as above the room, which is not heated or a room placed on the ground <math>R_{\lambda}=1,25</math> [m<sup>2</sup>K/W] (Fig. 26 or Fig. 27)</b>			
Profil1 30/50 mm	styrofoam EPS100 20 mm	1,28	50
Profil2 11/31 mm	styrofoam EPS100 40 mm	1,36	51
Profil4 20/47 mm	styrofoam EPS200 30 mm	1,35	50
Profil3 0/20	styrofoam EPS100 50 mm	1,32	50
<b>Required insulation thickness for floor in contact with the outside air (<math>T_z \geq 0</math> °C) <math>R_{\lambda}=1,25</math> [m<sup>2</sup>K/W] (Fig. 27)</b>			
Profil1 30/50 mm	styrofoam EPS100 20 mm	1,28	50
Profil2 11/31 mm	styrofoam EPS100 40 mm	1,36	51
Profil4 20/47 mm	styrofoam EPS200 30 mm	1,35	50
Profil3 0/20	styrofoam EPS100 50 mm	1,32	50
<b>Required insulation thickness for floor in contact with the outside air (<math>0</math> °C &gt; <math>T_z \geq -5</math> °C) <math>R_{\lambda}=1,50</math> [m<sup>2</sup>K/W] (Fig. 27)</b>			
Profil1 30/50 mm	styrofoam EPS100 30 mm	1,54	60
Profil2 11/31 mm	styrofoam EPS100 50 mm	1,63	61
Profil4 20/47 mm	styrofoam EPS200 40 mm	1,61	60
Profil3 0/20 mm	styrofoam EPS100 60 mm	1,58	80
<b>Required insulation thickness for floor in contact with the outside air (<math>-5</math> °C <math>\geq T_z \geq -15</math> °C) <math>R_{\lambda}=2,00</math> [m<sup>2</sup>K/W] (Fig. 27)</b>			
Profil1 30/50 mm	styrofoam EPS100 50 mm	2,07	80
Profil2 11/31 mm	styrofoam EPS100 70 mm	2,15	81
Profil4 20/47 mm	styrofoam EPS200 60 mm	2,14	80
Profil3 0/20 mm	styrofoam EPS100 80 mm	2,11	100

\*Ac – total height of insulation system



## Note

EN 1264 provides minimum requirements for thermal insulation thickness. In addition it is based on ambient temperature range  $-5$  °C  $\geq T_z \geq -15$  °C, while for the climate conditions in some of regions, ambient temperature may falls within different range.

Therefore, in order to ensure energy efficiency conditions, standard requirements must be extrapolated.

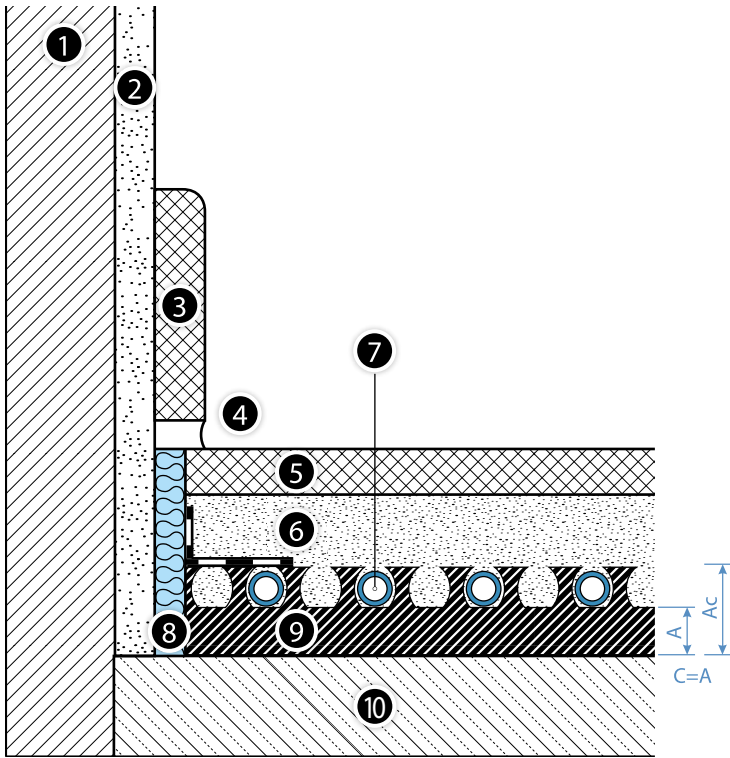

**Fig. 26.** Floor heater with KAN-therm Profil system board on the ceiling above an internal room.

1. Wall.
2. Plaster layer.
3. Baseboard.
4. Armor joint.
5. Floor lining.
6. Screed.
7. KAN-therm pipe.
8. Wall tape with PE protective apron.
9. KAN-therm Profil system board of insulation thickness A and total height Ac.
10. Concrete ceiling.

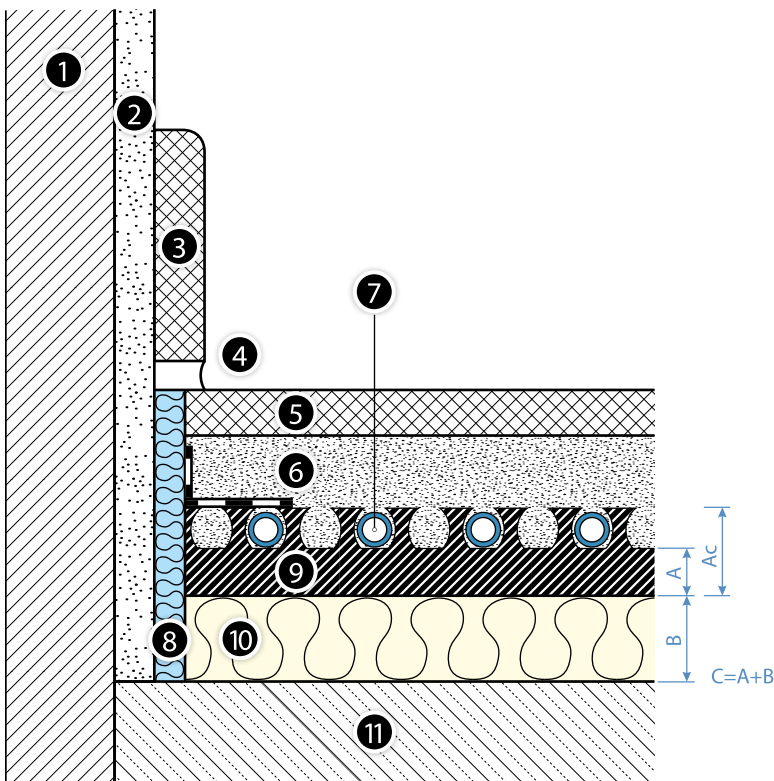

**Fig. 27.** Floor heater with KAN-therm Profil system board and supplementary insulation on the ceiling above internal not heated room and on the ceiling in contact with outside air.

1. Wall.
2. Plaster layer.
3. Baseboard.
4. Armor joint.
5. Floor lining.
6. Screed.
7. KAN-therm pipe.
8. Wall tape with PE protective apron.
9. KAN-therm Profil system board of insulation thickness A and total height Ac.
10. Supplementary board of thickness B.
11. Concrete ceiling.

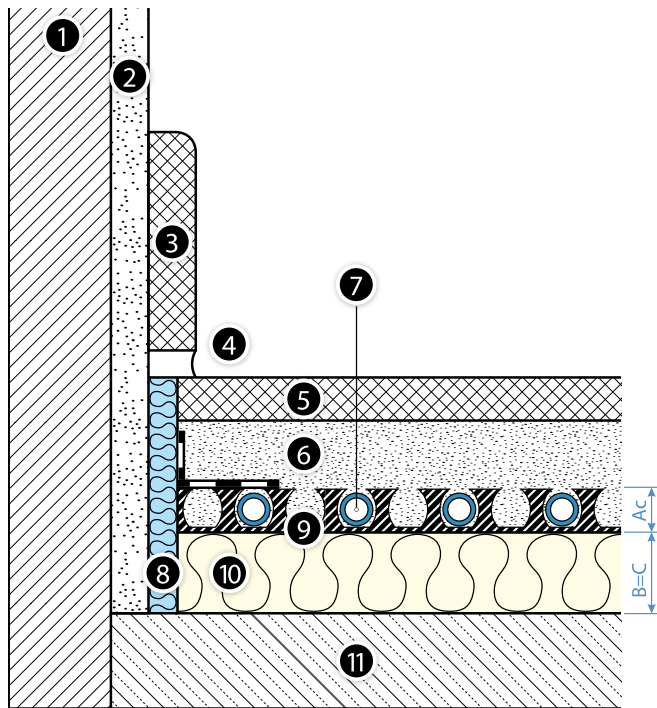

**Fig. 28.** Floor heater with KAN-therm Profil3 system board and supplementary insulation on the ceiling above the internal not heated room and on the ceiling laid out on the ground (damp insulation required!).

1. Wall.
2. Plaster layer.
3. Baseboard.
4. Armor joint.
5. Floor lining.
6. Screed.
7. KAN-therm pipe.
8. Wall tape with PE protective apron.
9. KAN-therm Profil3 system board of total height  $A_c$ .
10. Supplementary board of thickness  $B$ .
11. Concrete ceiling.

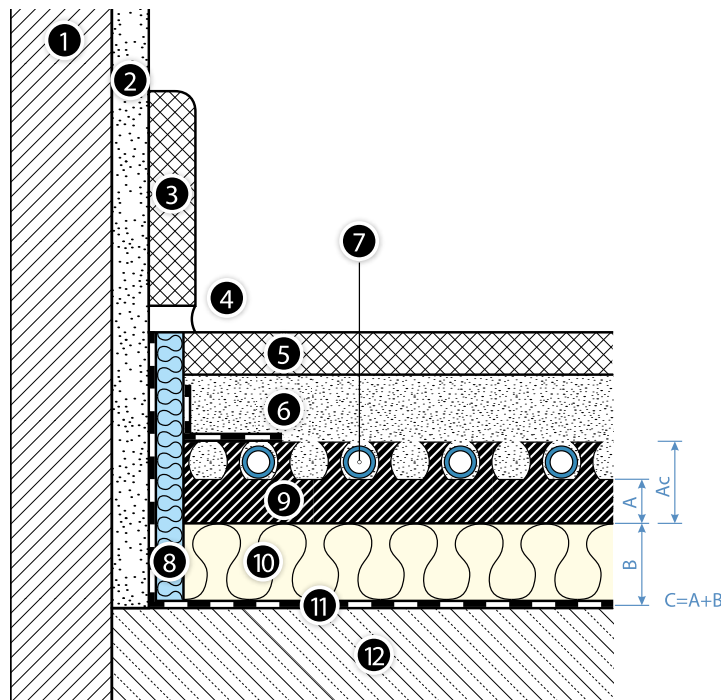

**Fig. 29.** Floor heater with KAN-therm Profil system board and supplementary insulation and damp-proof coating on the ceiling laid out on the ground.

1. Wall.
2. Plaster layer.
3. Baseboard.
4. Armor joint.
5. Floor lining.
6. Screed.
7. KAN-therm pipe
8. Wall tape with PE protective apron.
9. KAN-therm Profil system board of insulation thickness  $A$  and total height  $A_c$ .
10. Supplementary board of thickness  $B$ .
11. Damp insulation (only at the ground!).
12. Concrete ceiling.

### Elements of KAN-therm Profil system floor heater

- wall tape of foamed PE, with foil apron, dimensions  $8 \times 150$  mm,
- Profil1 30 mm – profiled EPS T-24 styrofoam board, with PS foil and tabs, dimensions  $0,8 \times 1,4$  m,
- Profil2 11 mm – profiled EPS200 styrofoam board, with PS foil and tabs, dimensions  $0,8 \times 1,4$  m,
- Profil4 20 mm – profiled EPS200 styrofoam board, with tabs, dimensions  $1,1 \times 0,7$  m,
- Profil3 – profiled mat made of PS foil, with tabs, dimensions  $0,8 \times 1,4$  m,
- additional EPS100 thermal insulation of 20, 30, 40 or 50 mm thickness,
- KAN-therm system PEXC, PERT, PERT<sup>2</sup>, bluePERT pipes with EVOH layer, of  $16 \times 2$ ,  $16 \times 2,2$  and  $18 \times 2$  diameter or KAN-therm system PERTAL, PERTAL<sup>2</sup> and bluePERTAL pipes with aluminum layer of  $16 \times 2$  and  $16 \times 2,2$  diameter,
- screed BETOKAN additive.

Tab. 6. Approximate unit consumption of materials [quantity/m<sup>2</sup>]

KAN-therm Profil system

Item designation	unit	The amounts at pipe spacing [cm]				
		10	15	20	25	30
KAN-therm pipes	m	10	6,3	5	4	3,3
Profil system insulation	m <sup>2</sup>	1	1	1	1	1
Supplementary insulation (if present)	m <sup>2</sup>	1	1	1	1	1
Wall tape 8 × 150 mm	m	1,2	1,2	1,2	1,2	1,2
BETOKAN supplement (at 6,5 cm screed)	kg	0,2	0,2	0,2	0,2	0,2

## Assembly guidelines

### General requirements

Floor heating/cooling mounting should be preceded by window and door frames mounting and completion of plastering. Works should be performed in the temperature above +5 °C.

The surface must be dry, clear, flat and even, in order to lay the system boards. Impurities should be removed and the discrepancy of levels compensated if necessary (with filler or levelling mortar). The acceptable tolerance of the support substrate unevenness for the floor heating installation is:

Distance between measuring points [m]	Surface unevenness [mm]	
	Wet system	Dry system
0,1	5	2
1	8	4
4	12	10
10	15	12
15	20	15

### Assembly stages



1. Assembly the installation cabinet and manifold.
2. Expand the wall tape with a plastic apron along the walls, columns, frames, etc. (A).
3. If required, lay the acoustic insulation (does not apply to Profil 1 boards) or additional thermal insulation on the whole surface.
4. Begin the arrangement of system boards from the corner of the room. After cutting the overlaps of PS foil on the shorter and longer side, arrange system boards so to arrange their longer side along the longer wall, while applying the overlap on the first row of tabs of the preceding board. If the last board of the first strip shall be too long, it should be cut, same for the fold from the side of a wall. The remaining segment of the cut board should be used as an initial one in the subsequent row. Arrange all boards in the room in such a manner (B).

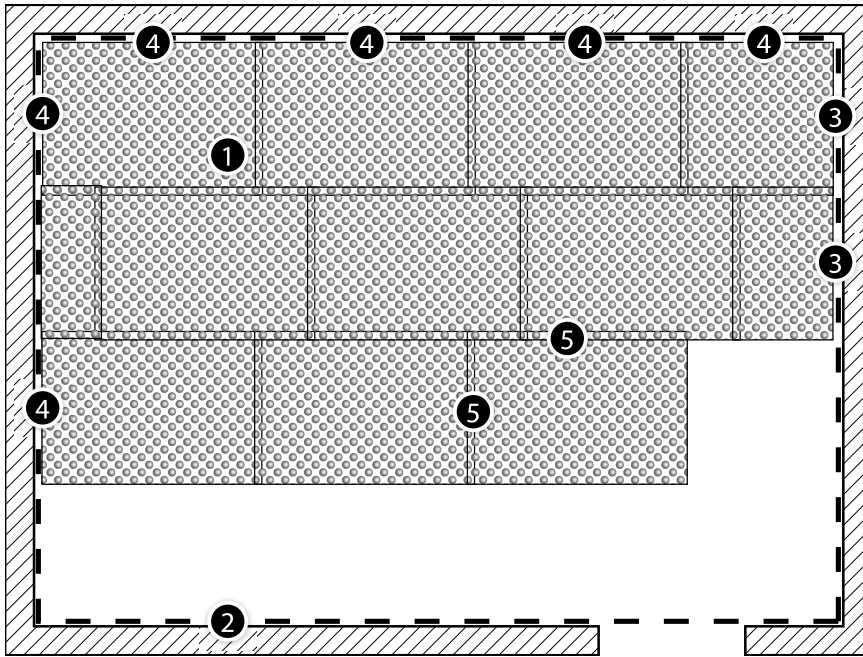

- 1. KAN-therm Profil system board.
- 2. Wall tape.
- 3. Board cut.
- 4. Foil overlap cutting.
- 5. Connecting boards of foil overlaps.

5. If the partition of hotplates with a dilatation is necessary, a dilatation profile with an adhesive flange should be mounted at the line of separation. The transit pipes passing through the profile should be arranged in protective sleeves of approximate length of 40 cm.
  6. Put the foil wall tape apron on the arranged boards. Protect against an ingress of liquid screed between the boards and tape by pressing the apron with a round rope made of polyethylene foam, pressed linearly into extreme tabs of the boards.
  7. Connect the pipe to the manifold. While maintaining the designed spacing (10–30 with increment of 5 cm) and configuration (series pattern and spiral pattern), lay the pipe on the boards, by pressing it between the tabs with leg. While changing direction be aware of the permissible bending radius of the pipe.
- Pipes on the approach to the manifold must be arranged in plastic profiling curves. To avoid the overheating of screed at pipes congestion (close to the manifold), arrange them in casing pipes or thermal insulation.
8. Perform a pressure test of arranged coils leakage in accordance with the rules applicable for the surface heating (see section Acceptance forms). After the test, leave the pipes under pressure.
  9. Cover the so prepared surface with screed of thickness and parameters provided in the project. After screed binding proceed to screed curing (annealing) in accordance with the procedure described in the "Acceptance forms" section.

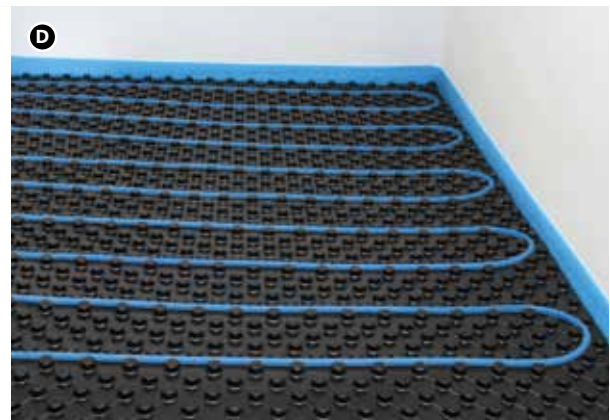

**!** Tables for thermal calculation of floor heatings and cooling performed in KAN-therm Profil system are provided in separate charts, attached to this handbook.

### 3.5 KAN-therm TBS system

Water floor heating based on the KAN-therm TBS system boards are a part of floor construction in dry system, classified according to EN 1264 standard as construction type B. The pipes are placed in profiled, grooved styrofoam boards, and then covered with boards of dry screed of thickness depending on designed permissible load of floor surface. The heat from the heating pipes is evenly radiated to the dry screed boards through steel radiating lamella, placed in the boards channels.

#### Application

- Floor heating in residential and general construction,
- Floor heating in renovated objects,
- Underfloor heating in buildings using light, wooden construction.

#### KAN-therm TBS system properties:

- low height of installation,
- light weight of the construction, which allows the mounting on ceilings with a low carrying capacity, wooden ceilings,
- fast mounting, which is a result of arrangement method and no need for screed curing,
- immediate readiness for work after the arrangement,
- possibility to apply in existing buildings and renovations,
- possibility to apply in sport facilities, in order to heat floors with point elasticity.

Tab. 7. Technical specifications of KAN-therm TBS system thermal insulation

Pipe spacing [mm]	TBS 16 EPS 150
	167, 250, 333
Overall thickness [mm]	25
Useful dimensions width × length [mm]	500 × 1000
Usable area [m <sup>2</sup> /board]	0,5
Thermal conductivity coefficient $\lambda$ [W/(m × K)]	0,035
Thermal resistance $R_{\lambda}$ [m <sup>2</sup> K/W]	0,70
Max. load kg/m <sup>2</sup> (kN/m <sup>2</sup> )	4500 (45)

Tab. 8. KAN-therm Profil system – minimum requirement for insulation thickness according to EN 1264

System insulation A/Ac* thickness	Supplementary insulation B thickness	Total insulation resistance R[m <sup>2</sup> K/W]	Total insulation thickness C [mm]
<b>Required insulation thickness above the heated room R<sub>λ</sub> =0,75 [m<sup>2</sup>K/W] (Fig. 30)</b>			
TBS 25 mm	styrofoam EPS150 20 mm	1,22	45
<b>Required insulation thickness above the room heated to lower temperature, as well as above the room, which is not heated or a room placed on the ground R<sub>λ</sub> =1,25 [m<sup>2</sup>K/W] (Fig. 30, Fig. 31)</b>			
TBS 25 mm	styrofoam EPS150 30 mm	1,48	55
<b>Required insulation thickness for floor in contact with the outside air (T<sub>z</sub> ≥ 0 °C) R<sub>λ</sub> =1,25 [m<sup>2</sup>K/W] (Fig. 30)</b>			
TBS 25 mm	styrofoam EPS150 30 mm	1,48	55
<b>Required insulation thickness for floor in contact with the outside air (0 °C &gt; T<sub>z</sub> ≥? -5 °C) R<sub>λ</sub> =1,50 [m<sup>2</sup>K/W] (Fig. 30)</b>			
TBS 25 mm	styrofoam EPS150 40 mm	1,74	65
<b>Required insulation thickness for floor in contact with the outside air (-5 °C ≥ T<sub>z</sub> ≥ -15 °C) R<sub>λ</sub> =2,00 [m<sup>2</sup>K/W] (Fig. 30)</b>			
TBS 25 mm	styrofoam EPS150 50 mm	2,01	75



**Note**

EN 1264 provides minimum requirements for thermal insulation thickness. In addition it is based on ambient temperature range -5 °C ≥ T<sub>z</sub> ≥ -15 °C, while for the climate conditions in some of regions, ambient temperature may falls within different range.

Therefore, in order to ensure energy efficiency conditions, standard requirements must be extrapolated.

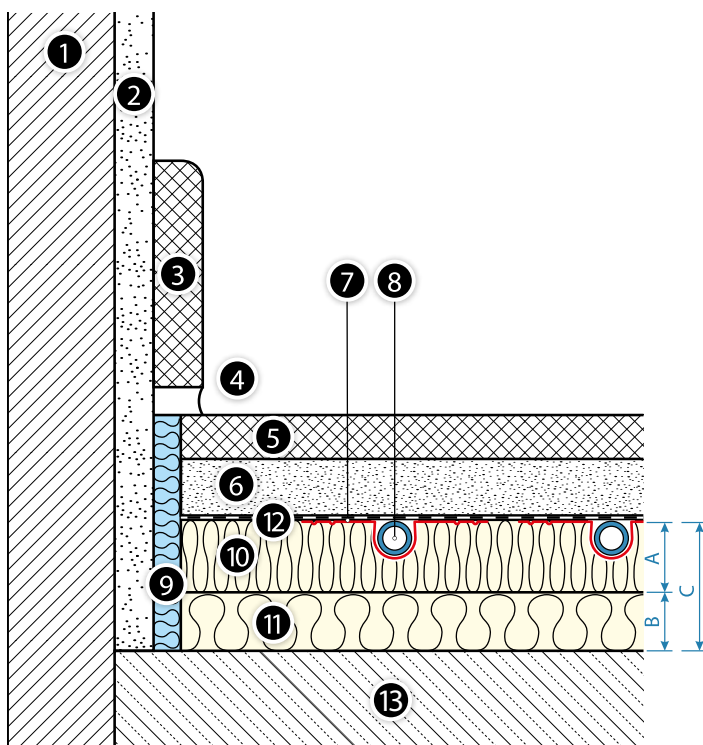

**Fig. 30.** Floor heater with KAN-therm TBS system board and supplementary insulation on the ceiling above internal room and on the ceiling in contact with outside air.

- 1. Wall.
- 2. Plaster layer.
- 3. Baseboard.
- 4. Armor joint.
- 5. Floor lining.
- 6. Dry screed.
- 7. Steel radiator (lamella).
- 8. KAN-therm pipe.
- 9. Wall tape.
- 10. KAN-therm TBS system board of thickness A.
- 11. Supplementary board of thickness B.
- 12. PE foil.
- 13. Concrete ceiling.

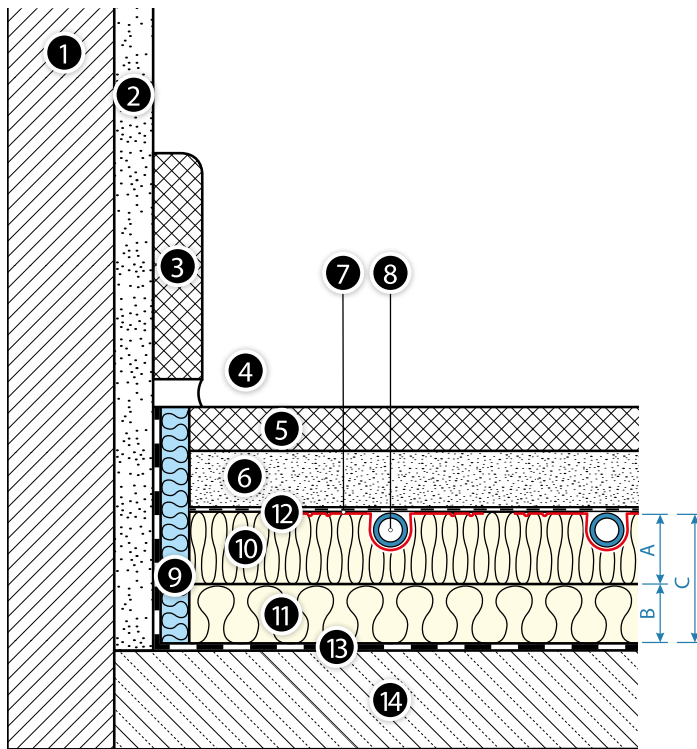

**Fig. 31.** Floor heater with KAN-therm TBS system board and supplementary insulation and damp-proof coating on the ceiling laid out on the ground.

1. Wall.
2. Plaster layer.
3. Baseboard.
4. Armor joint.
5. Floor lining.
6. Dry screed.
7. Steel radiator (lamella).
8. KAN-therm pipe.
9. Wall tape.
10. KAN-therm TBS system board of thickness A.
11. Supplementary board of thickness B.
12. PE foil.
13. Damp insulation (only at the ground!).
14. Concrete ceiling.

### Elements of KAN-therm TBS system floor heater

- wall tape of foamed PE, with foil apron, dimensions 8 × 150 mm,
- profiled TBS EPS 150 styrofoam board, dimensions 0,5 × 1,0 m, for the pipes of 16 mm diameter,
- steel TBS lamella (profiles) of 1,0 × 0,12 m dimensions, with notches every 0,25 mm, for the pipes of 16 mm diameter,
- PE foil of 0,2 mm thickness, in rolls,
- KAN-therm system PERTAL, PERTAL<sup>2</sup>, bluePERTAL pipes with aluminum layer or bluePERT heating pipes with EVOH layer of 16 × 2 and 16 × 2,2 diameter.

**Tab. 9.** Approximate unit consumption of materials [quantity/m<sup>2</sup>]

KAN-therm TBS system				
Item designation	unit	The amounts at pipe spacing [cm]		
		16,7	25	33,3
<b>KAN-therm pipes</b>	m	6	4	3
<b>TBS system insulation</b>	m <sup>2</sup>	1	1	1
<b>Supplementary insulation (if present)</b>	m <sup>2</sup>	1	1	1
<b>Wall tape 8 × 150 mm</b>	m	1,2	1,2	1,2
<b>PE TBS foil</b>	m <sup>2</sup>	1,1	1,1	1,1
<b>Metal TBS profile</b>	unit	5,1	3,4	2,5

## Assembly guidelines

### General requirements

Floor heating assembly should be preceded by window and door frames mounting and completion of plastering. Works should be performed in the temperature above +5 °C.

The surface must be dry, clear, flat and even, in order to lay the system boards. Impurities should be removed and the discrepancy of levels compensated if necessary (with filler or levelling mortar). The acceptable tolerance of the support substrate unevenness for the floor heating installation is:

Distance between measuring points [m]	Surface unevenness [mm]	
	Wet system	Dry system
0,1	5	2
1	8	4
4	12	10
10	15	12
15	20	15

Due to the thermal expansion of pipes and the resulting adverse effects (sound of moving pipes), straight sections of arranged pipes should not exceed the length of 10 m, for this reason it is recommended to use KAN-therm PERTAL, PERTAL<sup>2</sup> and bluePERTAL pipes with aluminum layer.

### Assembly stages



1. Assembly the installation cabinet and manifold. Expand the wall tape with a plastic apron along the walls, columns, frames, etc.
2. If required, lay the acoustic insulation or additional thermal insulation over the entire surface. Starting from the corner of the room arrange the system boards, so that their longer side was arranged along the wall, being aware of a proper planning of board zones arrangement with the change of pipes direction. Partial boards (cut) should be put at the centre of arranged surface, not at its end. If there are zones in the room, which are not heated by pipes, they should be filled with EPS200 supplementary boards of 25 mm thickness. Put a PE foil apron, fixed to the wall tape, on the TBS boards.



3. Place steel lamella (radiators) in the system board channels, separating one from another by 5 mm. Lamella feature transverse incisions (every 250 mm), which enable adjusting their length and matching with the length of the arranged boards. Arrange the lamella so that its transverse edge ends at approx. 50 mm from the change of direction of the pipe.
4. Starting from the manifold, arrange pipes in series pattern in lamella cavities with spacing of 167 or 250 or 333 mm, changing their direction in the board zone reserved for this purpose (with transverse channels). While changing direction be aware of the permissible bending radius of the pipe.

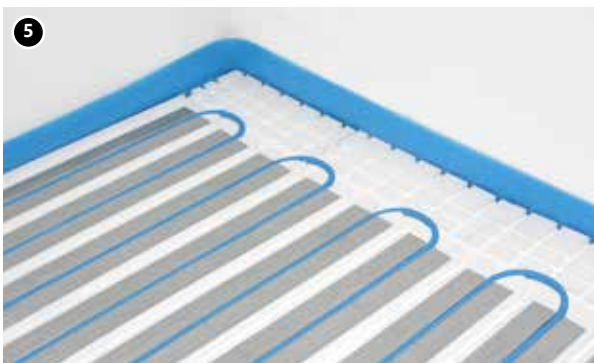

5. Attachable pipes, which are led to the manifold inconsistently with the system board channels lay-out or laying on the supplementary board should be arranged in channels cut with a special tool – TBS cutter.
6. Cover the whole surface of so prepared floor heater with a PE foil of 0,2 mm thickness, which serves as an acoustic and damp-proof insulation. Individual foil strips should be arranged with an overlap of 20 cm.
7. Perform a pressure test of arranged coils leakage in accordance with the rules applicable for the surface heating (see section "Acceptance forms"). After a successful test, leave the pipes pressurized.
8. Proceed with the arrangement of dry screed boards in accordance with manufacturer's recommendations, after arranging the floor lining, evenly cut the protruding dilatation edge strip.
9. The installation is ready for start-up.  
Tables for thermal calculation of floor heating performed in KAN-therm TBS system are provided in separate charts, attached to this handbook.

### 3.6 Monolithic constructions

Thermally active constructions are the solutions which utilize the thermal inertia of building construction elements to adjust the temperature in the rooms.

Those systems are applied for sole or supplementary heating or cooling of the rooms. They can, to a large extent, eliminate the disadvantages associated with the rooms air conditioning, based on the exchange of properly prepared air.

They are used only in the newly designed buildings, because they require the cooperation of constructors and heating and air conditioning specialists already at the stage of the building concept.

Monolithic constructions made of concrete are ideal for storing and radiating heat/cold, which is supplied by a system of pipes with cooling or heating water.

Coils made of pipes are arranged during the construction of massive ceiling or walls. Water flowing in the pipes that radiates or receives heat, thermally activates surface of the structure.

The thermo-active constructions function for the whole year – during the winter they radiate accumulated heat to the rooms, while during the summer they are primarily used to accumulate and radiate (during a day) cool to the rooms. Thus favorable conditions are provided, which ensure the high thermal and climatic comfort inside the object.

The system, due to low supply parameters (27–29 °C for heating, 16–19 °C for cooling) can cooperate with renewable heat sources such as various types of heat pumps.

Coils pipes of thermo-active ceiling arrangement is carried out at the construction site, during the ceiling reinforcement mounting. Pipes can be mounted to the elements of construction reinforcement or on a supplementary KAN-therm NET net, placed between the proper reinforcement of the ceiling. Pipes are mounted to the net with plastic handles or ties.

Coils are arranged with series pattern or in a double series system, with a spacing of 15 or 20 cm, most often at half the thickness of the ceiling.

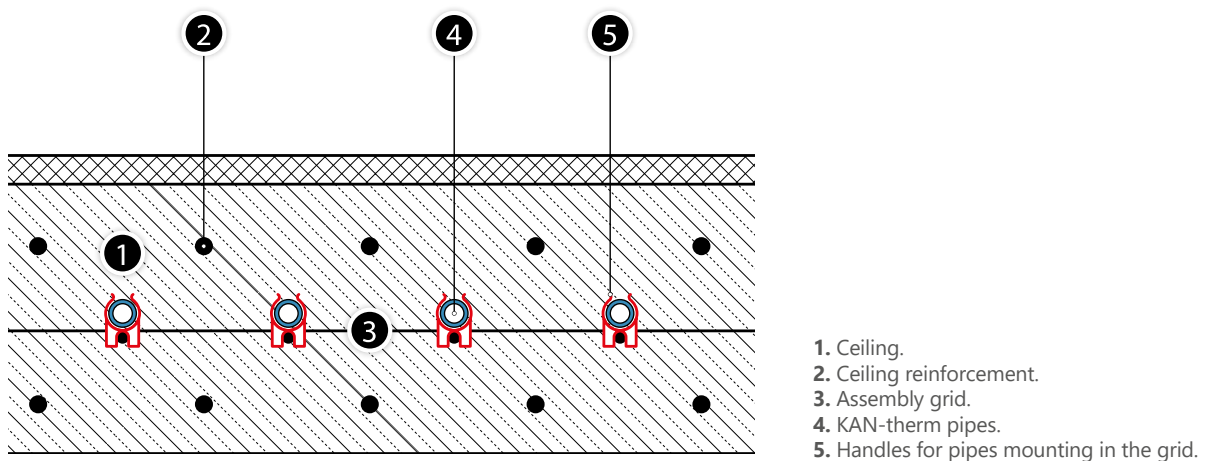

#### KAN-therm elements

- KAN-therm system PEXC, PERT and PERT<sup>2</sup> pipes with EVOH layer of 16×2, 16×2,2, 18×2, 20×2, 20×2,8 diameter,
- handles for pipes assembly on the NET net,
- ties for pipes mounting on the NET net,
- protective pipes for pipes of 16, 18 or 20 mm diameters.

On each floor the coils can be supplied through the connection to a heating circuits manifold, allowing the hydraulic balance of the system. They can also be supplied by the common manifold following the Tichelmann system, assuming that every circuit (coil) has the same hydraulic resistance.

### 3.7 Sports flooring heating in KAN-therm system

Sport halls or training and recreation rooms heating must fulfill a number of requirements, arising from their unique purpose and construction (large volume and height of the rooms, often a high degree of external walls "glazing", limited possibility of internal mounting of heating equipment due to the arrangement of rooms and user safety, the necessity to ensure a heat comfort and hygiene in the premises). In the sports and recreation objects the users are often undressed, and the uneven distribution of temperature (both vertically and horizontally, with the zones of cooler air) may cause not only colds, but injuries as well. An important aspect when choosing a heating method is also energy efficiency of the adopted system. The application of KAN-therm floor surface heating is a perfect way to ensure warmth and thermal comfort in this kind of objects.

The design of KAN-therm floor heating depends on type of the floor design. In practice, there are two types of sports floors: floors with point elasticity and surface elasticity.

#### Floors with point elasticity heating

The "working" surface is evenly distributed on perpetual, flexible coating, laid on a concrete surface. Heat radiation is made through the layer of screed, inside which the heating pipes are arranged. Such a floor is perfect for, e.g. practicing indoor tennis, as well as gymnastics and athletics.

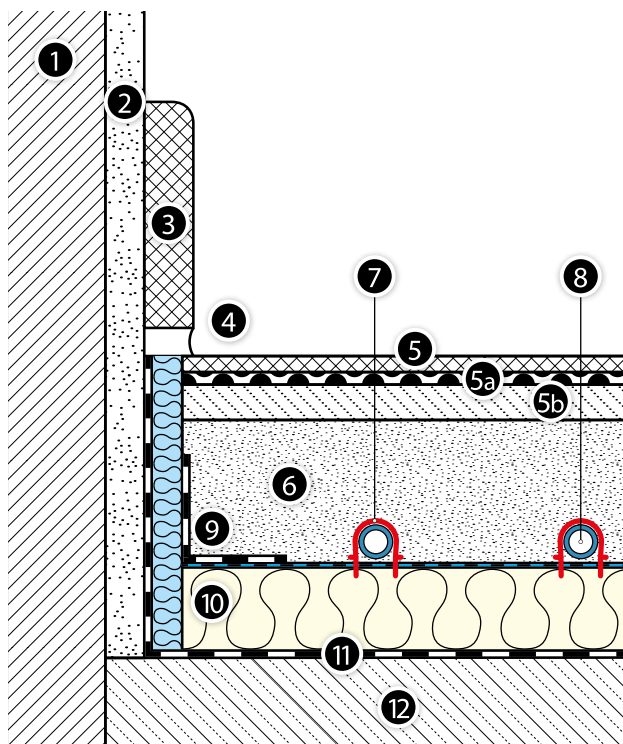

1. Wall.
2. Plaster layer.
3. Baseboard made of tiles.
4. Armor joint.
5. Sport floor lining.
- 5a. Coating with glass fiber.
- 5b. Elastic layer 10 mm.
6. Screed.
7. Pipe clip.
8. KAN-therm pipe.
9. Wall tape with PE protective apron.
10. KAN-therm Tacker system board of thickness A with metallised or laminated foil.
11. Damp insulation (only at the ground!).
12. Concrete ceiling.

The construction of floor heater is similar to construction of heating performed using a wet method in KAN-therm Tacker system. The only difference is the construction of flooring, which is composed of 10 mm elastic layer, coating with glass fiber and proper sports flooring, made of parquet, laminate or plastic linings. Pipelines are arranged (in series pattern and spiral pattern) on the thermal insulation, and then covered with a screed layer of total thickness of 65 mm. All heating circuits are connected to the KAN-therm manifolds, placed in wall-mounted cabinets.

Water heating of floors with point elasticity can be performed using the dry building system. For this purpose, KAN-therm TBS profiled boards with steel lamella (radiators) and KAN-therm PERT, PERT<sup>2</sup>, bluePERT and PEXC pipes with EVOH layer or PERTAL, PERTAL<sup>2</sup> and bluePERTAL pipes with aluminum layer of 16 mm diameter should be applied. Arranged (in accordance with the guidelines on **page 40**) KAN-therm TBS boards with pipes, are covered with subsequent layers of sports flooring.

The course and methodology of thermal and hydraulic calculations are the same as for KAN-therm Tacker heating system in wet method or KAN-therm TBS in dry method (taking into account the thermal resistance of all sports flooring layers). While calculating the heat demand, the specificity of sports objects has to be taken into account (large volume and room height).

## Heating of floors with surface elasticity

In case of floors with surface elasticity the proper floor is spread on a special wooden elastic construction, which is composed of wooden strips based on flexible tabs (vibration carrier) and supports. Parquet or PVC lining is applied as an external layer. Airspace between thermal insulation and floor is being heated. This type of floors is especially suitable for basketball, handball and volleyball practicing.

### Thermal insulation arrangement

The thermal insulation is arranged on the surface equipped with construction damp-proof insulation (in case of floors arranged on the ground). KAN-therm Tacker EPS 100 038 insulation boards of thickness depending on the localisation of the room (available thickness 20, 30, 50 mm) should be applied. The additional supplementary EPS 100 038 boards of 20, 30 and 50 mm thickness should be applied if necessary. KAN-therm Tacker boards are covered with metallised or laminated foil, with an overprint, which makes the arrangement of pipes easier.

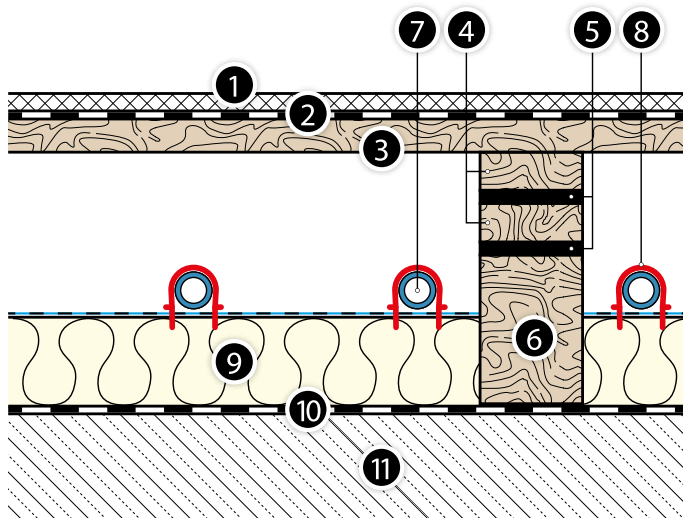

**Fig. 32.** Cross-section of the floor with surface elasticity, with a floor heating installation made of KAN-therm Tacker system elements.

1. Sport floor lining.
2. PE foil.
3. "Blind floor".
4. Double joist with flexible divider.
5. Flexible washers.
6. Wooden support.
7. KAN-therm pipe.
8. Pipe clip.
9. KAN-therm Tacker thermal insulation with metallised or laminated foil.
10. Moisture insulation.
11. Concrete ceiling.

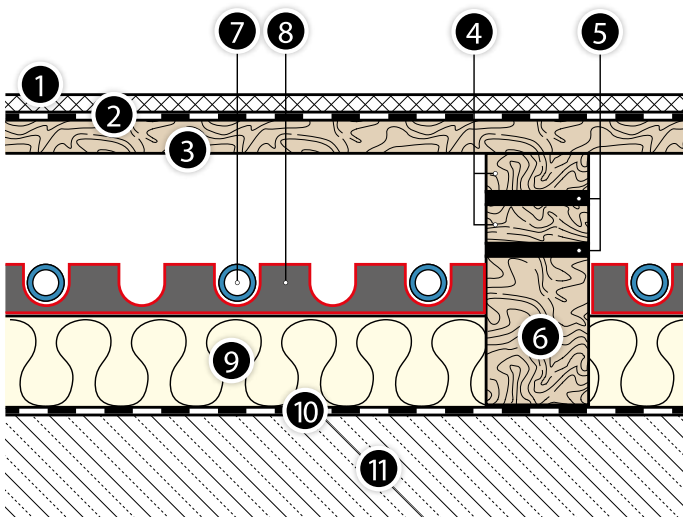

**Fig. 33.** Cross-section of the floor with surface elasticity, with a floor heating installation made of KAN-therm Rail system elements.

1. Sport floor lining.
2. PE foil.
3. "Blind floor".
4. Double joist with flexible divider.
5. Flexible washers.
6. Wooden support.
7. KAN-therm pipe.
8. Mounting rail for pipe fastening.
9. KAN-therm Tacker thermal insulation with metallised or laminated foil.
10. Moisture insulation.
11. Concrete ceiling.

After the arrangement of thermal insulation, holes should be made in it, which shall be used for the accommodation of floor supports in accordance with the recommendations of sports floor supplier. The number of holes and spacing between them depends on the adopted type of a floor.

## Pipes arrangement

KAN-therm PEXC, PERT, PERT<sup>2</sup> and bluePERT 16 × 2,2, 18 × 2, 20 × 2 and 20 × 2,8 mm with EVOH layer or PERTAL, PERTAL<sup>2</sup> and bluePERTAL 16 × 2, 16 × 2,2, 20 × 2 and 20 × 2,8 mm pipes with aluminum layer are applied. Pipes are mounted using clips for pipes fixed to insulation with a Tacker or by using KAN-therm Rail pipes assembly strips. Pipes are laid on the insulation in series pattern and spiral pattern in manifold arrangement or as separate, parallel loops attached to the collector header in following the Tichelmann system.

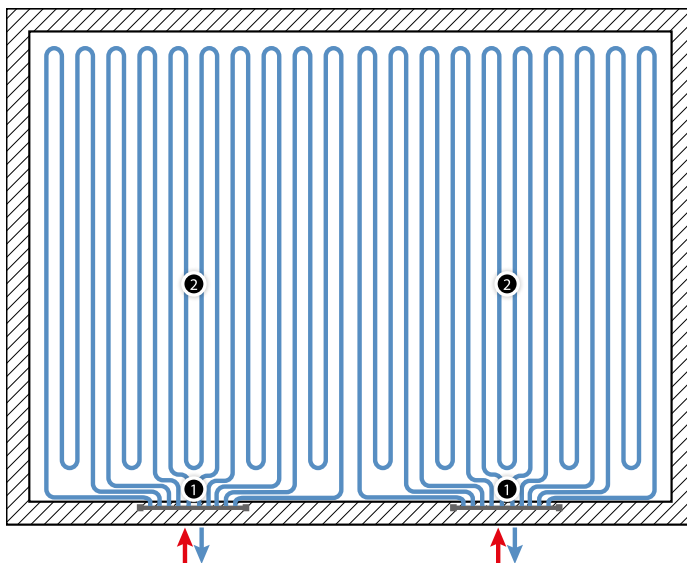

1. KAN-therm surface heating manifolds.
2. KAN-therm pipes with EVOH layer.

In the first case, the KAN-therm surface heating manifolds are used, which allow proper heat distribution and hydraulic adjustment of each circuit and heating section. Single manifolds enable to connect up to 12 (InoxFlow) or 16 circuits (plastic manifold).

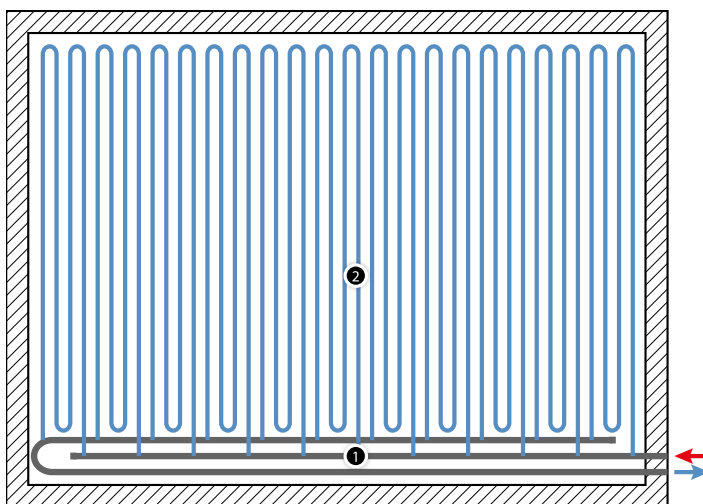

1. Manifold made of KAN-therm PERTAL pipes and ultraPRESS tees or KAN-therm stabiGLASS PPR pipes and PPR saddle fittings.
2. KAN-therm pipes with EVOH layer.

In the Tichelmann system, which guaranties even pressure distribution in the installation, heating circuits are connected through a three-way adapter (or KAN-therm PP saddle joints) to the supplying and return connectors laid under the floor, along the shorter and longer sides of sports hall.

Heating loops have a shape of repeated series pattern, placed perpendicularly to the collectors ("multiplicity" of series pattern depends on pipes diameter and the size of a hall).

Manifold collectors can be made of KAN-therm PERTAL 40 × 3,5 pipes with aluminum layer, connected with KAN-therm ultraPRESS press reducing tees of departure diameters of 16 × 2 or 20 × 2 mm and, for larger diameters of collectors (50 × 4 or 63 × 4,5 mm), with KAN-therm ultraPRESS tee with 1" male threads.

Possible configuration of KAN-therm PERT 20 × 2 mm pipes connection to the collector made of KAN-therm PERTAL pipes of 40 mm diameter:

**KAN-therm PERT 20 × 2 pipe with EVOH layer > KAN-therm ultraPRESS 40 × 3,5/20 × 2,0/40 × 3,5 tee > KAN-therm PERTAL 40 × 3,5 pipe with aluminum layer**

Alternatively, it is possible to apply KAN-therm stabiGLASS, KAN-therm PPR pipes of the diameter range between 40–110 mm and saddle joints:

- with KAN-therm ultraLINE or KAN-therm ultraPRESS system stubs for direct connection of heating loops,
- with ½" female thread for connecting heating loops using fittings with an male thread of KAN-therm ultraLINE or KAN-therm ultraPRESS system.

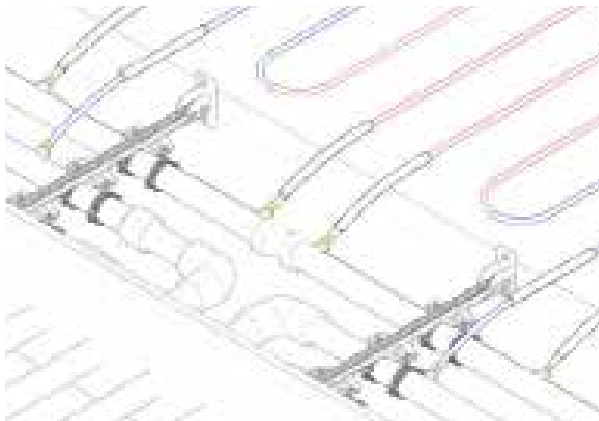

Possible configuration of KAN-therm PERT 18 × 2 mm pipes connection to KAN-therm stabiGLASS PPR collector made of pipes of diameter 50 mm:

**KAN-therm PERT 18 × 2 pipe with EVOH layer > 18 × 2,0/male thread ½" compression fitting > KAN-therm PP 50/ female thread ½" saddle joint > KAN-therm stabiGLASS PPR 50 × 6,9 pipe**

In the case of PEXC, PERT and bluePERT pipes with a diameter of 18 × 2, it is possible to use PP saddle fittings with a "Push" connection utilizing sliding sleeve technique. This configuration is recommended if it is necessary to mount the main PP collector underfloor (buried in the ground or in the concrete floor).

Departure spacing (three-way adapters or saddle joints) on the collector, depends on heating loop series pattern multiplicity and pipe spacing in series pattern, which is assumed to be in the range of 15–30 cm.

### **Floor with surface elasticity assembly**

Elastic sports floor is arranged subsequent to completion of installation works. Firstly, the wooden supports with elastic tabs should be placed in the holes, which were cut earlier in the insulation. Double joists (made of wooden, planed and dried strips) with an elastic divider (double vibration carrier) are mounted on those pads. Then, a so called sub floor made of wooden strips of 17–18 mm thickness and approx. 98 mm width is mounted on the joists. Prior to the arrangement of proper floor, polyethylene PE foil should be loosely unfolded on the sub floor. The final stage of heated sports floor mounting is the arrangement of proper external floor in the form of PVC lining or sports parquet (18–20,5 mm). In case of lining (for example made of linodur), firstly a load distribution layer of several millimetres thickness is arranged on the sub floor. All wooden elements should be of the highest quality, properly dried and seasoned. Linings made of plastics, as well as glues, varnishes, must possess a manufacturer's assurance that they are suitable for floor heating and have special labelling.

## Heat calculations

In KAN-therm heating of floors with surface elasticity arranged on joists, the air, which is not a good heat carrier, carries the heat between heating pipes and the surface of proper floor. For this reason, in order to ensure the proper thermal efficiency of heating surface, a higher temperature of heating circuits supply is applied, which amounts to the maximum of 55–65 °C with pipes spacing of 15–30 cm. With such parameters, it is possible to achieve the efficiency of 40–60 W/m<sup>2</sup>, which ensures an adequate thermal comfort in the occupied zone.

KAN-therm sports floor heating installation design must be carried out in cooperation with an architect and manufacturer of elastic floor, as well as with KAN company Technical Department.

## 4 Wall heating and cooling with KAN-therm system

### 4.1 General

KAN-therm surface heating components are well suited for various types of heating and cooling systems mounted in vertical construction bulkheads. KAN-therm water wall heating has all the benefits of surface heating and is additionally characterized by the following features:

- it may operate as the only and standalone room heating or be a complementary heating in case of insufficient surface of floor heating within a room. It may also support radiator heating, increasing comfort in rooms (used in the case of heated object modernization),
- it ensures a uniform (close to an ideal for human body) distribution of temperature in the room which results in high heating comfort,
- due to uniform heat absorption coefficients in heating and cooling, vertical bulkheads are perfect for dual systems (heating/cooling),
- heat emission is done by favourable radiation,
- the heating surface temperature may be higher than in the case of floor heating (up to 40 °C), which results in higher heat distribution, average heat efficiency is 120–160 W/m<sup>2</sup> (it is assumed it does not exceed max. temperature of the wall surface),
- due to lower thickness of the heating/cooling panel or small (or zero) thermal resistance of external wall layers, the thermal inertia is smaller and the temperature adjustment is much easier.

### 4.2 Construction of the KAN-therm wall heating/cooling system

#### Types of surface heater constructions - classification of wall solutions

- Type A – the pipes are located in the plaster layer.
- Type B – the pipes are in the upper part of thermal insulation layer or in an air gap.



1. Wall heating/cooling - A-type construction.
2. Wall heating/cooling - B-type construction.

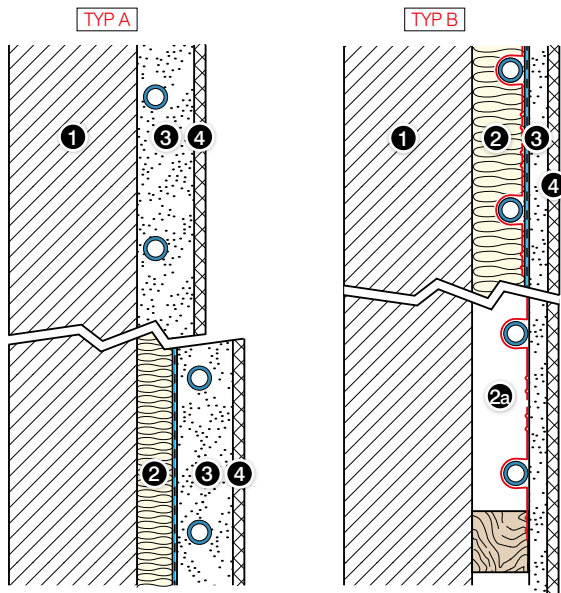

1. Wall.
2. Layer of thermal insulation (or air gap).
- 2a. Air gap.
3. Layer of plaster.
4. Wall lining or gypsum finish coat layer.

### General instructions

- The wall heating/cooling is mounted on external walls with heat transfer coefficient  $U \leq 0,35 \text{ W/m}^2 \times \text{K}$ . If the heat transfer coefficient exceeds  $0,4 \text{ W/m}^2 \times \text{K}$ , the wall should have an extra insulation.
- It is recommended to mount the unit near window openings, ex. under sills. It is also possible to mount the unit on internal walls.
- KAN-therm system pipes with the following diameters should be used:  
PB with EVOH layer –  $8 \times 1 \text{ mm}$ ,  
PEXC, PERT, PERT<sup>2</sup> or bluePERT with EVOH layer –  $12 \times 2, 14 \times 2, 16 \times 2 \text{ mm}$ ,  
PERTAL, PERTAL<sup>2</sup> or bluePERTAL with aluminum layer –  $14 \times 2, 16 \times 2 \text{ mm}, 16 \times 2,2 \text{ mm}$ .
- Recommended pipe distances - ( $\text{Ø}12\text{--}16 \text{ mm}$ ): 5; 10; 15; 20 cm, ( $\text{Ø}8 \text{ mm}$ ): 6; 8; 10; 12; 14; 16; 18; 20 mm.
- In the case of distances of 5 and 10 cm the pipes can be laid in double meandering.
- You should avoid covering the heating surfaces with furniture, paintings, curtains.
- Before installing the wall surface heaters all installation and electrical works nearby must be finished.

**Minimum distances from the pipes to adjacent bulkheads and construction openings are shown in the picture.**

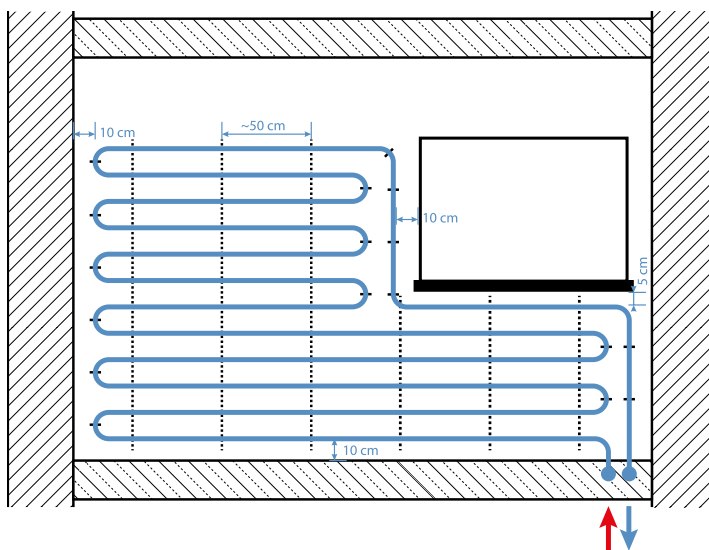
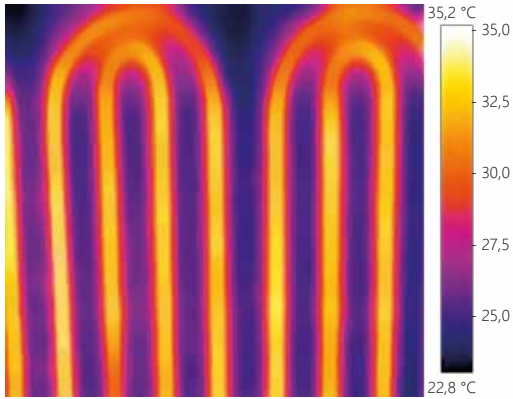

Fig. 34. Assembly distances in wall heating.

The heating walls themselves do not require dilatation unless the manufacturer of the used plaster imposes such a requirement. If the installation is carried out properly using the wet method, the plaster is permanently bonded with the supporting base material (wall structure) and there is no risk of its separation. In most cases it is sufficient to additionally reinforce joints and corners with plaster mesh. The coil supplying pipes should be led in insulation or in a protective pipe. When the floor turns into a wall, the pipe should be led in a 90° tray or a system bend should be used.

Heating loops are supplied by KAN-therm splitters to surface heating. The coils can also be supplied in Tichelmann system, assuming the uniform lengths of individual circuits attached to the system.



To locate heating pipes in existing wall installations you can use a thermal camera or a special thermosensitive foil.

### 4.3 KAN-therm wall heating/cooling systems

As in the case of floor surface heating there are two methods of wall heating/cooling installation: "wet" or "dry".

#### KAN-therm Rail "wet" system

In the case of installing the heating/cooling panel with the "wet" method (type A), KAN-therm Rail system includes mounting the surface installation pipes using Rail plastic slats, attached to thermal installation or directly to the wall surface using the wall tape, metal pins or wall plugs.



#### Application:

- wall heating/cooling in residential and general buildings,
- wall heating/cooling in renovated objects.

Pipes with diameter of 8, 12, 14 or 16 mm are mounted on the wall in assembly strips and then coated with a layer of plaster with total thickness of 30-35 mm, creating the heating panel. Minimum thickness of the plaster above the pipe surface is 10 mm.

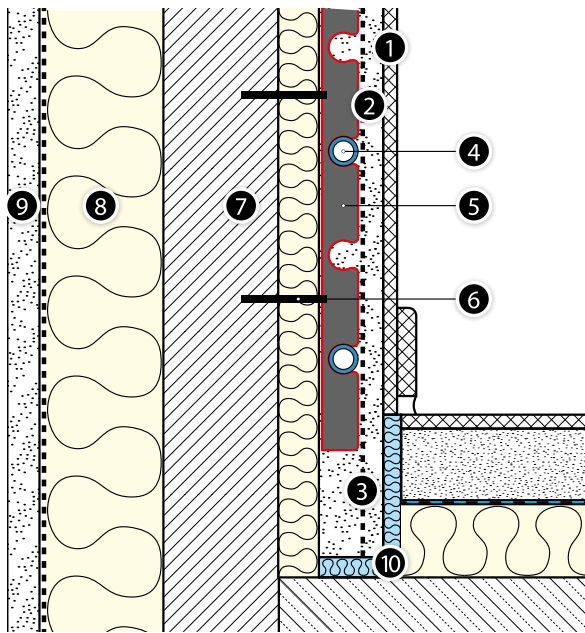

**Fig. 35.** KAN-therm Rail heating installation/wall cooling construction.

1. Wall lining (wallpaper, ceramic tiles).
2. Plaster.
3. Construction mesh 7 × 7 mm.
4. KAN-therm pipe.
5. Assembly rail.
6. Wall plug.
7. Wall constructions.
8. Thermal insulation.
9. External plaster.
10. Dilatations.

#### Wall heater components

- PB, PEXC, PERT, PERT<sup>2</sup>, bluePERT pipes with EVOH layer or PERTAL, PERTAL<sup>2</sup> and bluePERTAL pipes with aluminum layer of the KAN-therm system,
- KAN-therm Rail assembly strips for pipes with diameter of 8, 12, 14 or 16 mm,
- Plastic arc leading to 8×1 mm pipes,
- 90° plastic or metal guides for pipes with diameter of 12–18 mm,
- Electrical conduits for pipes with diameter of 8–16 mm,
- Dilation wall tape.

#### Installation guidelines

- For pipe installation use KAN-therm Rail assembly strips for diameters 8, 12, 14 or 16 mm attached by plug walls. Assembly guide distance is max. 50 cm.
- The heating panel plaster should have a good thermal conductivity (min. 0,37 W/m<sup>2</sup> × K), temperature resistance (approx. 70 °C for cement-lime plasters, 50 °C for gypsum plasters), flexibility and low expansion.
- The type of plaster should be adapted to the room. Cement-lime or gypsum plasters can be used, also clay mortars.
- Recommended are the ready-to-use plasters, ex. KNAUF MP-75 G/F.
- The air temperature during plaster work should not be lower than 5 °C.
- The plaster should be laid in stages: the first layer should completely cover the pipes. Apply fiberglass plumbing mesh (40×40 mm) onto the fresh layer and apply the second layer with thickness of 10-15 mm. The mesh stripes must be overlapped and also overlap adjacent surfaces (approx. 10-20 cm).
- The maximum width of the heating area is 4 m, height max. 2 m.
- The approximate area should not exceed 6 m<sup>2</sup> heating/cooling circuit, also the max. permissible pipe lengths in loops must be observed - see on **page 55**.
- During plastering the pipes should be filled with water under pressure (min. 1,5 bar).
- Plaster heating can be initiated when it is dry (time is specified by the plaster manufacturer - from 7 days for gypsum plasters to 21 days for cement plasters).
- The plaster may be painted, covered with a wallpaper, structural paint or ceramic cladding.

## KAN-therm TBS "dry" system

Water wall heating based on KAN-therm TBS system panels belongs to the dry system, qualified as a B-type construction in accordance with EN 1264. The pipes are placed in profiled, grooved styrofoam boards and then covered with dry screed boards with thickness depending on designed loadbearing surface. The heat coming from heating pipes is evenly distributed to dry screed boards through steel radiating laths placed in board grooves.



### **Application:**

- Wall heating in residential and general buildings,
- Wall heating in renovated objects,
- Wall heating in buildings using light, wooden construction.

### **KAN-term TBS system is characterized by:**

- low height,
- construction lightness that enables assembly on low-bearing constructions, wooden constructions,
- speed of assembly, resulting from the way of installation and no need to care for screed,
- immediate readiness to work after installation,
- possibility of use in existing buildings, renovations.

Pipes with diameter of 16 mm are placed in KAN-therm TBS board grooves equipped with steel sheet radiators. TBS boards are attached between horizontal slats or steel 25×50 mm profiles to the wall surface. Such construction is covered with PE foil that serves as acoustic and anti-humidity insulation, then plasterboards are attached to slats.

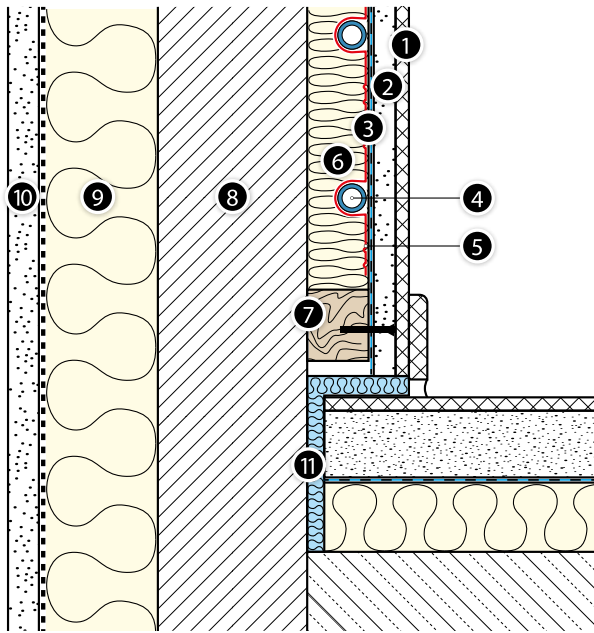
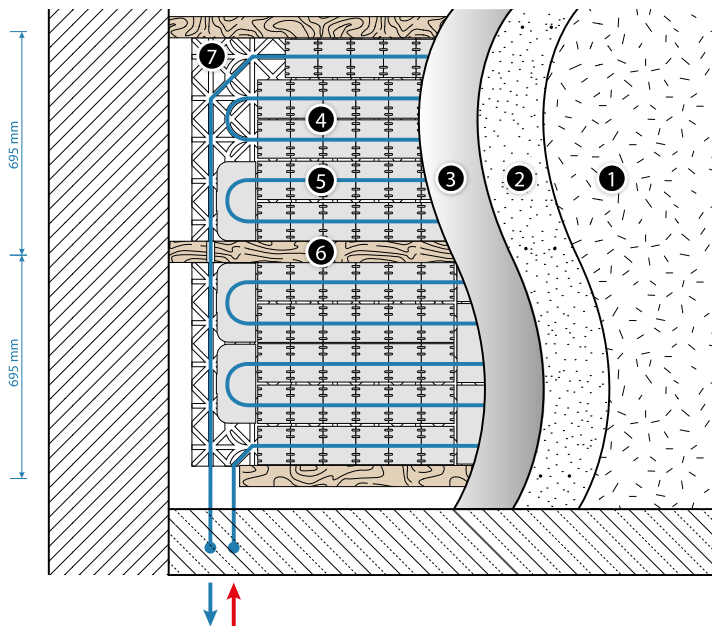

**Fig. 36.** KAN-therm TBS wall heating construction.

1. Wall lining (wallpaper, ceramic tiles).
2. Dry plaster (plasterboard).
3. PE foil.
4. KAN-therm pipe.
5. Steel profile (radiator).
6. TBS 16 system board.
7. 25 x 50 mm wooden slat.
8. Wall constructions.
9. Thermal insulation.
10. External plaster.
11. Dilatations.

### Wall heater components:

- KAN-therm TBS panels with dimensions 1000 x 500 x 25 mm, with steel sheet laths (radiators),
- Wooden slats or 25 x 50 mm steel profiles,
- PERTAL, PERTAL<sup>2</sup> or bluePERTAL KAN-therm system pipes with aluminum layer with diameter of 16 x 2, 16 x 2,2 mm,
- PE foil with 2 m width and 0,2 mm thickness,
- Electrical conduits for pipes with diameter of 16 mm,
- Dilation wall tape,
- Dry plaster, plasterboards.



**Fig. 37.** KAN-therm TBS wall heating installation cross-section.

1. Layer of wall lining (tiles, structural paint, wallpaper, etc.).
2. Dry plaster (plasterboard).
3. PE foil.
4. Steel radiator (lath).
5. KAN-therm pipe.
6. Wooden slats.
7. KAN-therm TBS board.



Fig. 38. KAN-therm TBS 16 board with steel radiating laths.

**Installation guidelines:**

- The wall surface must be clean, smooth and vertical,
- KAN-therm TBS panels are mounted between slats to the wall surface using proper glues for styrofoam boards,
- The slat distance is (in axes) 695 mm,
- The pipes should be laid with distance 166 or 250 mm,
- The PE foil should have a 200 mm overlap.

**4.4 "Dry" system, KAN-therm Wall gypsum-fibre boards**

**System characteristics**

The basic element of KAN-therm Wall system are gypsum-fibre boards used for heating&cooling, wall or ceiling installations.

The boards consist of gypsum and cellulose fibre obtained in paper recycling process. Both natural materials are mixed with water without additional binding substances, pressed under high pressure and then impregnated with a water-proof substance and cut to proper formats. The material composition ensures that the gypsum-fibre board is universal, non-flammable and has a high mechanical resistance, therefore it can also be used in humid rooms.



No glues are used to manufacture gypsum-fibre boards, the boards are odourless and do not contain any harmful substances.

Heating&cooling panels of the KAN-therm Wall system in "dry" construction are gypsum-fibre boards with milled grooves and built-in polybutylene PB pipes with diameter of 8 × 1 mm used in the KAN-therm system.

Heating&cooling panels of the KAN-therm Wall system are available in several sizes with different pipe distances and various filling of the board through the pipe. Thanks to such configuration it is very easy to prepare a heating&cooling installation even on most geometrically complex wall surfaces. Inactive wall surfaces may be covered with complementary gypsum-fibre boards available in KAN-therm Wall system offer.

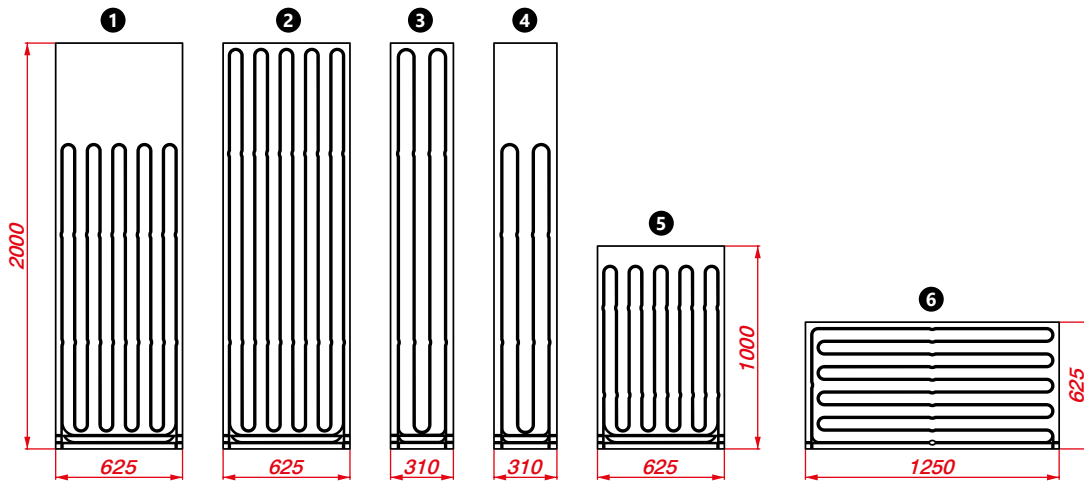

Panel No.	Panel name and type	height × width × thickness [mm]	Pipe spacing [mm]	Product code	Pipe length in panel [m]	Power Qn [W] 40/35/20 °C
1	Wall heating panel with pipe PB 8 × 1 (75%)	2000 × 625 × 15	62,5	1800188005	15,8	92,5
2	Wall heating panel with pipe PB 8 × 1 (100%)	2000 × 625 × 15	62,5	1800188004	20,4	123,4
3	Wall heating panel with pipe PB 8 × 1 (100%)	2000 × 310 × 15	77,5	1800188001	8,3	59,3
4	Wall heating panel with pipe PB 8 × 1 (75%)	2000 × 310 × 15	77,5	1800188002	6,4	44,5
5	Wall heating panel with pipe PB 8 × 1 (100%)	1000 × 625 × 15	62,5	1800188000	9,4	61,7
6	Wall heating panel with pipe PB 8 × 1 (100%)	625 × 1250 × 15	62,5	1800188006	11,8	77,1
<b>OPTIONAL</b>	Wall complementary panel - covering board without grooves	2000 × 625 × 15	—	1800188007	—	—
<b>OPTIONAL</b>	Wall heating panel - covering board with grooves, without pipe	2000 × 625 × 15	62,5	1800188003	—	—

Each heating&cooling board has a some redundant pipes, so called service sections, that enable making a hydraulic connection into larger heating&cooling sets. Service sections are attached at the base of each board. To make a hydraulic connection of single boards into larger sets, the service sections should be extended from the groove and then profiled properly towards the main pipes.

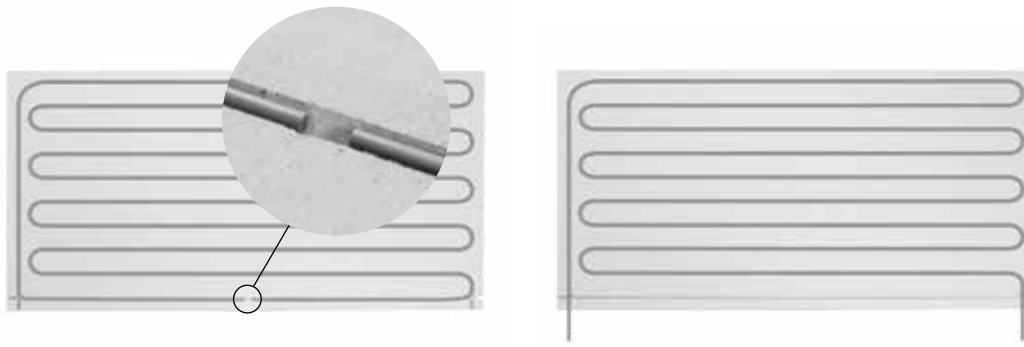

## Technical specifications of gypsum-fibre boards

### Tolerances at fixed humidity for standard size boards

Length, width	± 1 mm
The difference of diagonals	≤ 2 mm
Thickness: 15	± 0,3 mm

### Density, mechanical parameters

Board's density	1150 ± 50 kg/m <sup>3</sup>
Water vapour transmission rate (μ)	13
Heat flow λ	0,32 W/mK
Heat capacity c	1,1 kJ/kgK
Brinell hardness rating	30 N/mm <sup>2</sup>
Absorbability after 24 h	< 2%
Coefficient of thermal elongation	0,001%/K
Expansion at relative air humidity by 30% [20 °C]	0,25 mm/m
Humidity at 65% relative air humidity and 20 °C	1,3%
Fire classification acc. to PN EU	A 2
pH coefficient	7-8

## Range of application

**Heating&cooling boards can be used in execution of any construction concepts, from cellars to attics, including:**

- steel or wooden particle walls,
- partition walls in apartments,
- external walls,
- fire-resistant walls,
- covers/shaft walls,
- wall linings (external and internal),
- dry plaster,
- in the case of composite boards - for heating,
- ceilings,
- ceiling linings,
- attics (ceiling linings, sloping ceilings and knee walls).

KAN-therm Wall system boards can also be used as all-purpose fire-retardant construction boards and as finishing heating boards for rooms with elevated humidity.



## Fire protection

Gypsum-fibre boards with thickness of 15 mm, approved by European Technical Approval ETA-03/0050, are classified as non-flammable construction material, class A2-s1 d0, in accordance with EN 13501-1.

Areas of application		Category
1	Rooms and corridors in residential buildings, hotel rooms with bathrooms.	A2, A3
2	Rooms and corridors in office buildings, clinics.	B1
	Sale areas up to 50 m <sup>2</sup> , basic areas in residential, office or similar buildings.	D1
3	Corridors in hotels, nursing homes, boarding schools, surgery rooms without heavy equipment.	B2
	Rooms with tables, ex. classrooms, cafés, restaurants, canteens, reading rooms, waiting halls.	C1
4	Corridors in hospitals, nursery homes, etc. treatment rooms, surgery rooms with heavy equipment.	B3
	Rooms for large number of people, ex.: concert and congress halls, schools, churches, theatres, cinemas, council rooms, etc.	C2
	Continuous movement areas, ex.: museums, exhibition halls, utility buildings, hotels.	C3
	Rooms for large number of people, ex.: churches, theatres, cinemas, council rooms.	C5
	Sports halls, dancing halls, gyms, stages.	C4
	Sales rooms in shops and markets.	D2

## Transport and storage

Depending on the order, KAN-therm Wall system gypsum-fibre boards are provided on pallets or pads. Unless it is otherwise agreed, the gypsum-fibre boards are delivered on pallets, covered with foil to ensure protection against humidity and contamination.

When the boards are stored, you should consider the ceiling load-bearing capacity, assuming that the board's density is approx. 1150 ± 50 kg/m<sup>3</sup>.

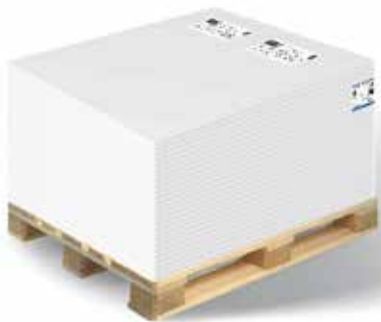

Gypsum-fibre boards should be generally stored in horizontal position on flat and dry floor and protect them from humidity, especially from rainfall.

Humid boards can be mounted only when they are completely dry. During laying the boards you should choose the flat floor. Storing the boards in vertical position may lead do deformations and damage of edges.

### Note!

The boards should be transported horizontally using the fork-lift trucks or other transport trucks. Single boards should be carried only in vertical position.

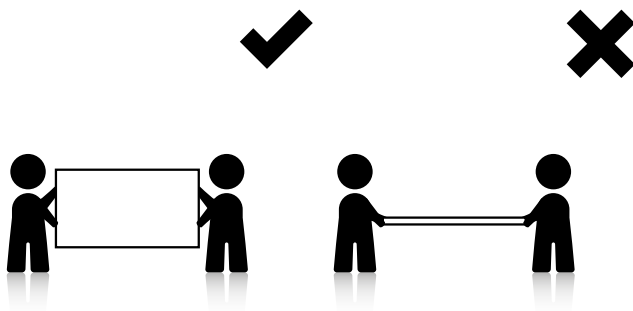

## Assembly

Dry construction of KAN-therm Wall system is executed by mounting the heating&cooling boards to special bearing construction made of metal or wood. It is also possible to mount the boards directly on wall surfaces by gluing them – in this case the surfaces must be even.

### Supporting constructions of walls and ceilings

The supporting construction may be made of wood (laths, wooden frame construction) or steel profiles. If the mounting is done using brackets, the supporting construction must not be flexible. If required, the construction should be stiffened. The supporting construction must have a wide contact area to gypsum-fibre boards of KAN-therm Wall system. The contact of all board edges must be at least 15 mm.

The wood for the supporting construction must be applicable for construction purposes and dry during the assembly.

Only steel profiles protected from corrosion should be used, with minimum thickness of 0,6 mm, meeting the requirements of EN 14195 and 13964.

Also the connecting elements and places should be properly protected from corrosion.

Maximum distances of supporting construction elements for gypsum-fibre boards in any application are shown in the table below.

**Tab. 1. Spacing for Fermacell gypsum-fibre boards with thickness of 15 mm**

Area of application (type of construction)	Utility class, includes the air humidity	Max. space of axes supporting laths / supporting profiles in mm
Vertical areas (partition walls, wall linings)	—	313
	Rooms used in homes <sup>1)</sup>	400
Linings of ceilings, roofs and suspended ceilings	Construction and/or the use at temporary high air humidity <sup>2)</sup>	350

<sup>1)</sup> Ex. humid rooms used in homes in residential areas or rooms with temporarily increased air humidity.

<sup>2)</sup> Ex. in case of wet screed or plaster, however not in rooms with constantly high air humidity (ex. wet rooms, etc.).

## Boundary conditions

- the assembly space provided applies regardless of the direction of assembly,
- the linings cannot be overloaded by additional weights (ex. insulation materials),
- the point load up to 0,06 kN (based on DIN 18181:2008-10) should be considered for each metre of width of each board,
- in the case of fire protection dimensions you should observe the data included in proper fire testing certificates.

When the supporting construction is mounted on the wall, the construction should go along the longitudinal edge of the wall board.

In the case of ceiling mounting it is required that the wooden or metal construction ran across the longitudinal edge of the wall board. If in the case of ceiling mounting the supporting profiles are parallel to the longitudinal edge of the board, the board may flex during the system operation.

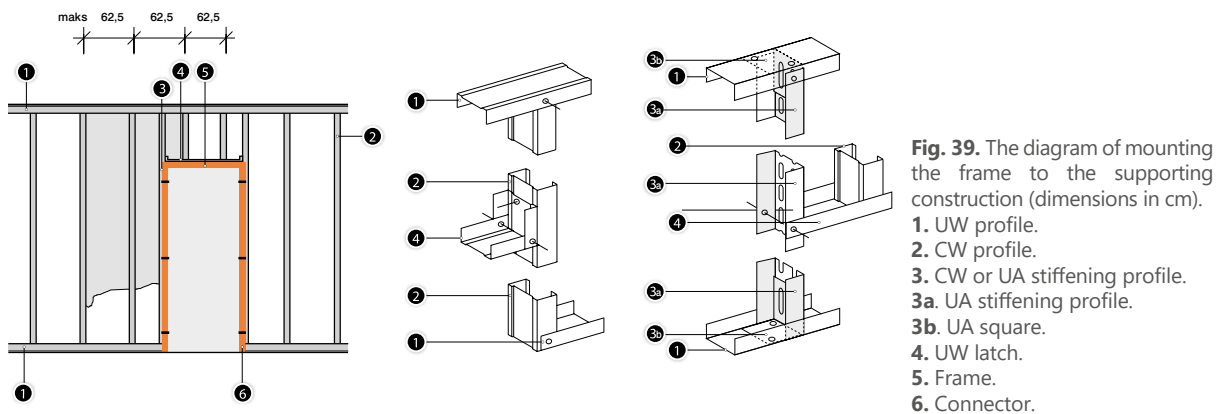

If the wooden supporting construction is used for the KAN-therm Wall heating&cooling boards with dry method, the following recommendations should be followed:

- The wood should be applicable for wooden constructions and dry during the assembly.
- The minimum cross-section of the laths should be 30 × 50 mm.
- The construction of the wooden frame should not be flexible.
- The space of axes of the bearing construction should not be more than 313 mm.

If the steel supporting construction is used for the KAN-therm Wall heating&cooling boards with dry method, the following recommendations should be followed:

- All metal profiles and connecting elements should be protected from corrosion.
- The frame should be prepared in accordance with DIN 18182.
- The thickness of the sheet used for metal profiles should be 0,6 mm - 0,7 mm.
- C and U profiles should be attached vertically to the wall and to the front.

**!** **The details on the construction are given in technical documentation of the profile manufacturers.**

**!** **Note!**

When heating&cooling boards of KAN-therm Wall system are assembled, you cannot make cross gaps. The side offset of at least 30 cm should be maintained.

## Ceiling linings made of gypsum-fibre boards

When ceilings are mounted, you should prepare the construction supporting elements in accordance with the table below. Parameters of other supporting constructions must be calculated not to exceed the permissible deflection, which is 1/500 of the distance. The table below includes the permissible deflection. The distances of supporting profiles or supporting laths depend on board thickness.

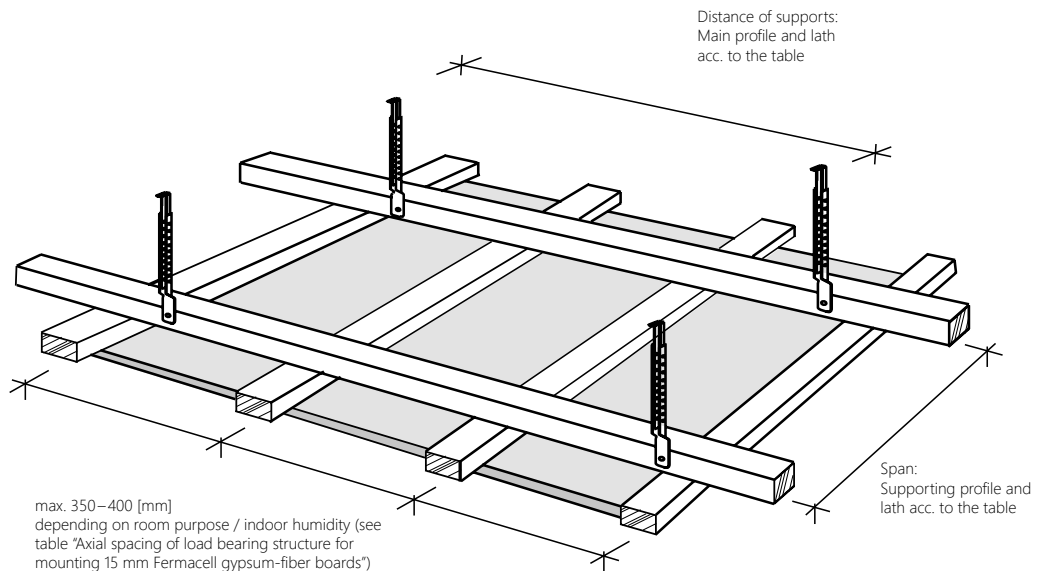

**Tab. 2. The distances and cross sections of profiles and laths for ceiling and suspended ceiling linings**

Dimensions of supporting construction [mm]		Permissible distance in mm <sup>[1]</sup> at total capacity load <sup>[4]</sup>		
		Up to 15 kg/m <sup>2</sup>	Up to 30 kg/m <sup>2</sup>	Up to 50 kg/m <sup>2</sup>
<b>Steel sheet profiles <sup>[2]</sup></b>				
<b>Main profile</b>	CD 60 × 27 × 0,6	900	750	600
<b>Supporting profile</b>	CD 60 × 27 × 0,6	1000	1000	750
<b>Wooden laths (width × height)</b>				
<b>Main laths attached directly</b>	48 × 24	750	650	600
	50 × 30	850	750	600
	60 × 40	1000	850	700
<b>Main suspended laths</b>	30 × 50 <sup>[3]</sup>	1000	850	700
	40 × 60	1200	1000	850
<b>Supporting laths</b>	48 × 24	700	600	500
	50 × 30	850	750	600
	60 × 40	1100	1000	900

<sup>[1]</sup> The concept of profile or main lath distance means the distance between hangers, and in the case of profiles or supporting laths the axial distance of profiles or supporting laths, see Fig. above.

<sup>[2]</sup> Profiles available commercially made of steel sheet (according to DIN EN 18182 or DIN EN 14195).

<sup>[3]</sup> Only in relation with supporting laths, 50 mm wide and 30 mm high.

<sup>[4]</sup> When the total capacity load is determined, you should consider possible additional weights, such as lighting or built-in elements.

Individual elements of the supporting construction must be connected using special, recommended connecting elements: bolts or threaded nails screwed across or brackets in the case of wood (DIN EN 1050-3) and special fittings in the case of steel profiles.

To prepare the suspended ceilings commercially available fittings should be used, such as nonius hangers, band iron with openings or slots, wires or threaded rods.

To mount the supporting construction to the massive ceiling you should use certified wall plugs, recommended for high loads.

The cross section of the hangers should be adapted to ensure static safety of the suspended ceiling. The above mentioned should be followed in relation to fire-fighting constructions and constructions with double lining.

### **Fitting elements and distance of anchorages**

Heating&cooling boards can be attached directly to the supporting construction by:

- fixing with bolts for steel supporting construction (Fig. 1),
- fixing with bolts for wooden supporting construction (Fig. 1),
- fixing with brackets for wooden supporting construction (Fig. 2),
- fixing with brackets for gypsum-fibre boards (double lining) (Fig. 3).



### **Attaching the boards with bolts and brackets**

A special feature of KAN-therm Wall system boards (gypsum-fibre) is the fact that they can be fixed to the supporting construction with bolts and brackets mounted right at the board edges (approx. 10 mm), without breaking effect.

In the case of steel construction made of steel profiles (thickness of 0,7 mm) the gypsum-fibre boards should be screwed in using dedicated self-drilling screws without drilling any holes. Using other screws may make the board assembly more difficult. The screws should be screwed using an electric drill (power 350 W, speed of rotation 0-4000 rpm) or an ordinary drill with screwing tip. In the case of profiles made of thicker sheet, ex. stiffening profiles, you should use self-drilling screws with drilling tip.

In the case of wooden construction the gypsum-fibre boards must be attached with dedicated screws. For wooden supporting constructions it is much easier and faster to fix the boards using brackets.

When the boards are fixed, you should obey the rule that at least 2 parallel board edges should be on the supporting construction. All fixing elements should be inserted deep enough into the gypsum-fibre board and mudded with joint filler.

The boards must be fixed in such way to avoid tension. When boards are fixed, you should keep the order of fixing on supporting construction axes – beginning from the board centre and moving toward the edge or fixing from one edge to another.



### Note!

It is forbidden to fix the boards first in the corners, then the rest, but successively from one side to the other.

In the case of two-layer lining it is possible to fix the external layer of boards using brackets or screws directly to the first layer, regardless of the supporting construction. The external layer of the boards is fixed using the joint offset ( $\geq 20$  cm). To connect gypsum-fibre boards you should use brackets-expansion staples with wire thickness  $\geq 1,5$  mm and shortened arm. The length of bracket arms should be lower by 2-3 mm than the total thickness of two layers of boards. The distances of brackets and screws are given in the table below.

Tab. 3. The distance and use of fixing elements for non-supporting particle walls per 1 m<sup>2</sup> of the particle wall with gypsum-fibre boards

Board thickness/construction	Brackets-staples (galvanized and resin impregnated) d $\geq 1,5$ mm, spine width $\geq 10$ mm			Fermacell self-drilling screws d = 3,9 mm		
	Length [mm]	Span [cm]	Use [pcs./m <sup>2</sup> ]	Length [mm]	Span [cm]	Use [pcs./m <sup>2</sup> ]
<b>Metal – single-layer lining</b> 15 mm	—	—	—	30	25	20
<b>Metal – 2-layer lining/second layer attached to the construction</b> First layer: 12,5 mm or 15 mm Second layer: 10 mm, 12,5 mm or 15 mm	— —	— —	— —	30 40	40 25	12 20
<b>Wood – single layer lining</b> 15 mm	$\geq 44$	20	24	40	25	20
<b>Wood – 2-layer lining/second layer attached to the construction</b> First layer: 15 mm Second layer: 12,5 mm or 15 mm	$\geq 44$ $\geq 60$	40 20	12 24	40 40	40 25	12 20

Tab. 4. Span and use of fixing elements in ceiling constructions with gypsum-fibre boards per m<sup>2</sup> of the ceiling

Board thickness/construction	Brackets-staples (galvanized and resin impregnated) d $\geq 1,5$ mm, spine width $\geq 10$ mm			Fermacell self-drilling screws d = 3,9 mm		
	Length [mm]	Span [cm]	Use [pcs./m <sup>2</sup> ]	Length [mm]	Span [cm]	Use [pcs./m <sup>2</sup> ]
<b>Metal – single-layer lining</b> 15 mm	—	—	—	30	20	16
<b>Metal – 2-layer lining/second layer attached to the construction</b> First layer: 12,5 mm or 15 mm Second layer: 10 mm, 12,5 mm or 15 mm	— —	— —	— —	30 40	30 20	12 16
<b>Wood – single layer lining</b> 15 mm	$\geq 44$	15	20	40	20	16
<b>Wood – 2-layer lining/second layer attached to the construction</b> First layer: 15 mm Second layer: 12,5 mm or 15 mm	$\geq 44$ $\geq 60$	30 15	12 22	40 40	30 20	12 16

## Attaching boards to smooth surfaces

### Requirements for the surface

The surface must be dry and hard, strong enough, should not shrink and should be insulated from humidity and protected from possible wetting. The surface cannot be made of clay. In the case of hard foams you should consult the manufacturer.

Before attaching the boards you should remove the loose plaster, old paint coatings, remains of the wallpaper, wallpaper glue, boarding oil and contamination. If the use of cast asphalt/wet screed was foreseen, the assembly of gypsum-fibre boards using the gypsum glue and pointing can be initiated only when it is bound.

Due to special properties of gypsum glue the surface that easily absorbs humidity, ex. cellular concrete, does not require any special initial processing. Small irregularities of the walls (up to 20 mm) can be flattened using the gypsum glue directly during the board assembly. In the case of larger irregularities it is necessary to flatten the whole surface.

If you are unsure about the surface load capacity, you should use mechanical supports, such as wooden laths, etc.

### Assembly on moderately flat surface

Such surface is generally made of bricks, limestone and sand stones, hollow bricks.

The gypsum glue is applied in patches onto the reverse side of the board or directly on the wall. The distance of glue patches/bands should not exceed 600 mm in the case of gypsum-fibre boards. The distance from the band to the edge of the board should not exceed 50 mm.

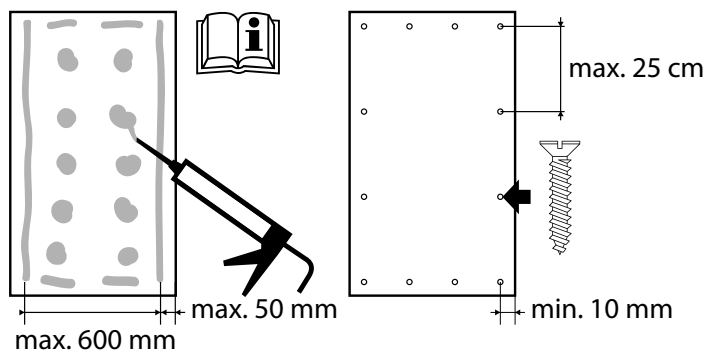

### Assembly on very flat surface

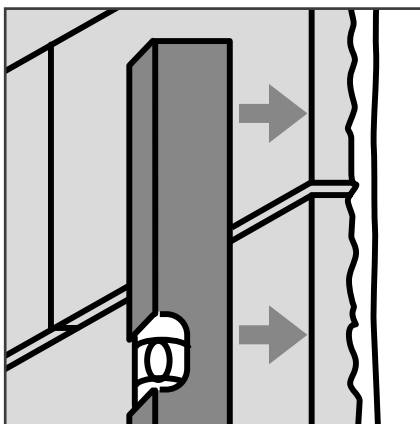

This method should be considered in the case of cellular concrete walls or surfaces with very flat concrete areas.

Slightly diluted gypsum glue is applied in bands onto the reverse side of the gypsum-fibre board in such way that the distance from the band to the edge is no more than 50 mm.

The gypsum glue should not enter the joints. The distance between bands for gypsum-fibre boards with thickness of 15 mm (d = 10 mm) should not exceed 600 mm.

A board covered with gypsum glue should be lightly pressed to the wall and set vertically, ex. by pressing with a spirit level.

Before the assembly of boards the cellular concrete wall should be cleaned thoroughly, ex. using a brush.

The gypsum glue should bind the board with the surface in all places. In the points of board joints in the door, shelf or sink areas the boards must be completely covered with gypsum glue. Those components should be attached to a massive surface. Static fixing is related to the wall.

## Making joints

A joint – the place where KAN-therm Wall system boards are connected can be made in two ways: as a glued joint or a mudded joint. Both techniques of making joints apply to boards with perpendicular edges.

### Glued joint

Gypsum-fibre boards can be mounted only when dry. You should use only the **Fermacell** gypsum glue or greenline joint glue.

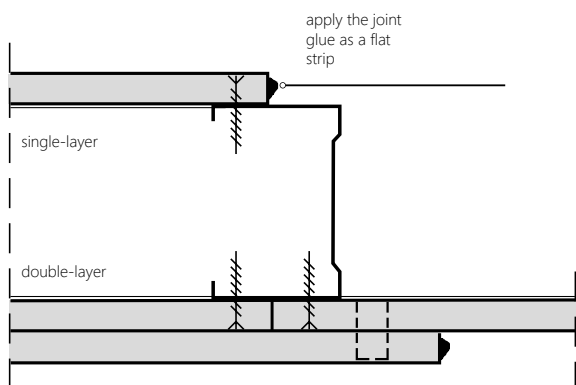

When joints are made, you should ensure that the board edges are free from dust and that the glue band is applied in the middle of the edge, not onto the frame. Pre-cut edges are the best for glued joints. The edges of boards cut at the site should be cut perpendicularly and must be perfectly straight.

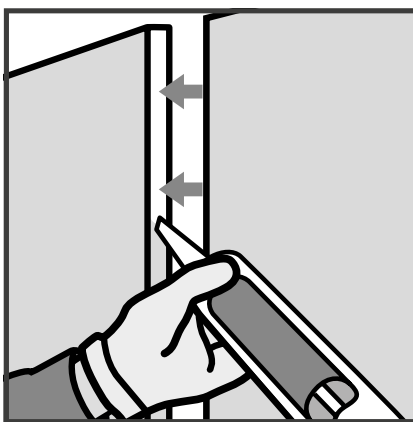

Fig. 40. Moving the 310 ml cartouche along the board edge. Cut the nozzle in the case of the 15 mm board.

The first board is attached to the supporting construction. Then behind this should apply a flat band of joint glue from the cartouche onto the vertical edge of the board. Next you should press the second board to the first. When both boards are pressed, it is important that the glue fills the joint completely (excessive glue visible after pressing). The maximum width of glued joint must not exceed 1 mm. You should not press the boards to remove all the glue from the joint.

Depending on the room temperature and air humidity, the glue is cured after 18-36 hours; when it is cured, the excess of the glue should be completely removed using a putty knife or a wide trowel. Then the connections and fixing elements in boards should be mudded with joint filler for surfaces.

### Mudded joint

To make a reliable and strong connection of the boards with perpendicular edges using the mudded joint technique, you should fill the gypsum-fibre boards with a special joint filler, ex. from **Fermacell**.

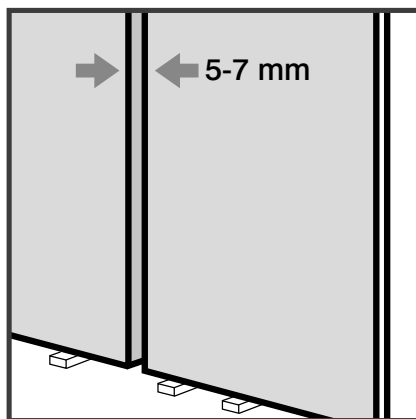

Whether or not the gypsum-fibre boards are attached to the supporting construction using screws or brackets-staples, you should assure the proper joint widths between the boards. In the case of KAN-therm Wall heating&cooling board with thickness of 15 mm, the joint thickness should be 7 - 10 mm.

The joints are mudded with a joint filler without need to use the reinforcing tape (except for plastering with a thin layer of structural plaster, below which you need to reinforce the joint with tape).

Screw heads or brackets-staples should be mudded using the same material.

Before mudding you should ensure that the joints are free from dust. You can start mudding only when the boards are dry, i.e. free from humidity coming from the building construction. If you plan any works with wet screed or plaster in the room, you should make joints only when they are dry.

The joint is made in two steps: initial mudding and final mudding. Final mudding can be done only when the first layer of putty is dry.

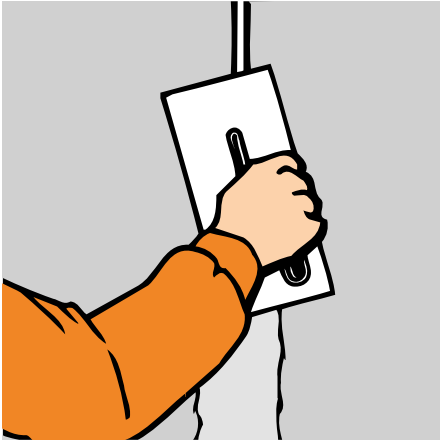

The putty for joints should be inserted into joints between boards until they are completely filled. To achieve connection from both sides, the mass is applied on one edge of the board and then distributed to the opposite edge. In this way the heads of fittings and various cracks get mudded. Possible irregularities can be ground (using the grinding mesh or sand paper type 60) after drying the putty applied in the first work cycle. The final mudding is done after removing grinding dust from the surface.

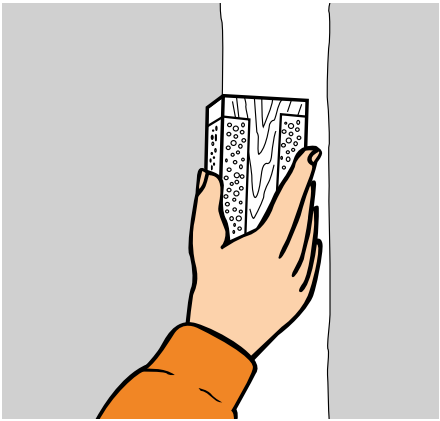

### **Gaps and connections**

Gaps and connections should be considered at the design stage of the project. The following principles related to construction and design should be followed:

- Expansion gaps of the building should be continued in walls by making expansion gaps with the same possibilities of movement.
- The wall surfaces should be marked every 10 m according to DIN 18181 in both longitudinal and transverse direction by making expansion gaps.
- The connections with ceiling and walls should be done using the sliding connection.

## Sliding connection

Connecting the heating&cooling wall boards with surrounding surfaces should be made as a sliding connection. Temperature-based elongation of wall elements is compensated by sliding connections. The connecting profile is visible within the sliding joint. The front edge of gypsum-fibre boards can be covered with an edge profile.

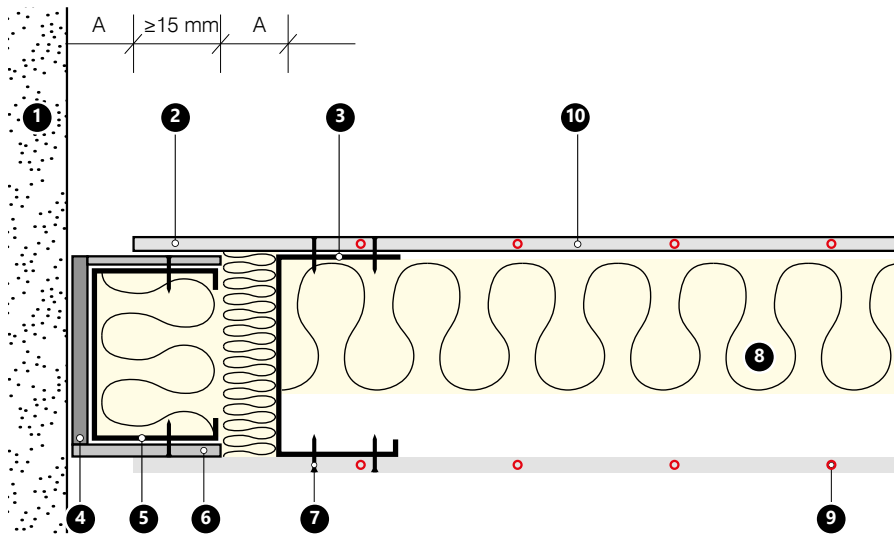
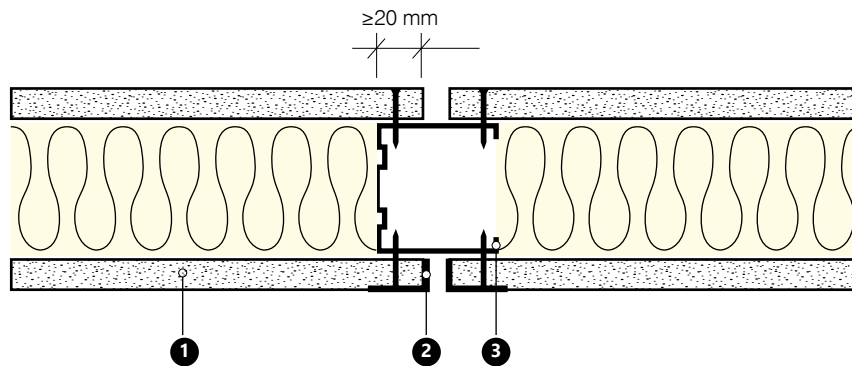

**Fig. 41.** Sliding connection with the wall.

1. External wall.
  2. Inactive wall area.
  3. CW bent profile, galvanized.
  4. Flexible closing.
  5. Connecting profile.
  6. Complementary gypsum-fibre board.
  7. Quick assembly screw.
  8. Thermal insulation.
  9. KAN-therm pipe, PB 8 × 1 mm.
  10. KAN-therm Wall system heating and cooling board.
- A Movement range 15 mm.

## Open gap

An open gap can be used to separate the coverage for decorative purposes or to separate the narrowings. The gap can be covered with a profile.



**Fig. 42.** Open gap.

1. KAN-therm Wall system heating and cooling board.
2. Edge profile or other (alternative).
3. Support profile.

## Expansion gap

Within an expansion gap you need to separate the whole wall construction. It is used in the case of covering the construction gaps or when the length of the wall needs to be separated into sections. In the case of KAN-therm Wall heating&cooling boards with dry method such separation should be done every 10 m.

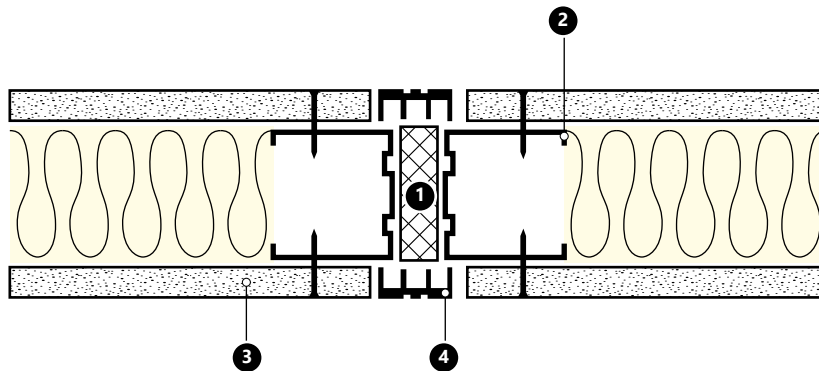

Fig. 43. Expansion gap.

1. flexible insulating liner (e.g. mineral material).
2. Support profile.
3. KAN-therm Wall system heating and cooling board
4. Joint profile.

## Preparation of the surface to finish

Before applying paint, wallpaper or tiles you should verify the condition of the surface for finishing. The board surface with joints must be dry, undamaged, without any stains or dust. Moreover, you should:

- remove the remains of gypsum and plaster,
- fill all connections with joint filler, final putty or gypsum filler for surface mudding,
- verify if all mudded areas are smooth – grind if required.

Gypsum-fibre boards are impregnated with a rain repellent. Additional impregnation or application of an additional layer is required only when the manufacturer of the finishing system recommends that due to the gypsum surface, ex. in the case of thin-layer plasters or structural coatings of paint or glue. In such a case you should use low-hydrated masonry primers. For multi-layer systems you should observe the drying time recommended by the manufacturers.

## Conditions at the site

You should ensure that the humidity of gypsum-fibre boards does not exceed 1,3%. Boards gain that humidity within 48 hours if the air humidity in the room is kept below 70% and the temperature is above 15 °C. All screeds and plasters must be dry. The board surfaces must be free from dust.

Final finishing of KAN-therm Wall system gypsum-fibre boards (coating with paints, wallpapers, plasters or tiles) should be done in accordance with **Fermacell** recommendations.



### Note!

Before final finishing of KAN-therm Wall system gypsum-fibre boards (painting, applying wallpapers) you must:

- make a hydraulic connection for the heating&cooling boards,
- flush, fill and vent the pipe system in the boards,
- make a tightness test of the heating&cooling system.

### Determining the location of heating pipes

The location of heating pipes can be determined using the thermosensitive foil during the heating process. For that purpose you should place the foil on the surface and switch on the wall heating. Thermal foils are re-usable.



### Hydraulic connection of KAN-therm Wall system boards

In order to ensure proper information of heating&cooling construction of KAN-therm Wall system gypsum-fibre boards you need a design of board location based on the architectural project (consultations with an architect) and possible discussions with an investor related to additional equipment and furniture, ex. paintings, shelves, high furniture, etc. Using the information obtained, you need to determine the active heating&cooling areas.

The efficiencies of KAN-therm Wall system gypsum-fibre boards are shown in the efficiency tables for KAN-therm Wall system in the annex to this document.

The tables are also available on the KAN website.



#### **Note!**

The maximum permissible temperature of heating&cooling KAN-therm Wall system gypsum-fibre boards in continuous heating operation is +40 °C. Higher temperatures may damage the wall boards.

In order to ensure thermal comfort in the room during heating with KAN-therm Wall system boards maximum permissible temperatures of the wall surfaces should be considered.

The design should ensure the temperature shall not exceed +40 °C.

In order to ensure optimum work of the heating&cooling hydraulic system made of KAN-therm Wall system gypsum-fibre boards, you should observe the following guidelines:

- When you select/design the installation of the heating system with dry method (KAN-therm Wall system) you should note that the temperature can drop by 5 °C. The permissible drop of pressure for the whole heating loop should not exceed 20 kPa. Due to high pressure losses it is recommended to connect the boards one by one with max. total 8 mm pipe length of 40 m. In the case of longer sections, i.e. above 40 m, it is recommended to connect boards or board sets using the Tichelman system. Due to the control capabilities of the flowmeters used in KAN manifolds, the minimum 8 × 1 mm pipe length directly connected to single manifold circuit (including the connection line) is 30 m (note: does not apply to manifolds with control valves).

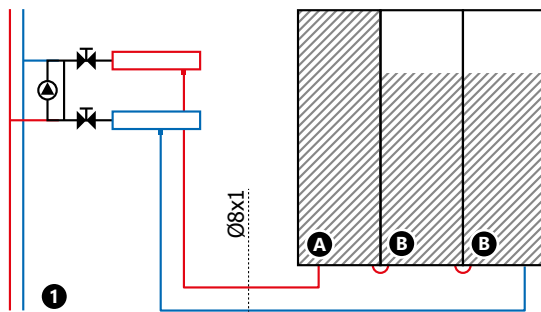

$$30 \leq L1 + L2 + \dots \leq 40 \text{ m}$$

Fig. 1	Area	Size (mm)	Q (W)	L (m)
Board A	100%	2000 × 310	59,3	≈8,3
Board B	75%	2000 × 310	44,5	≈6,4

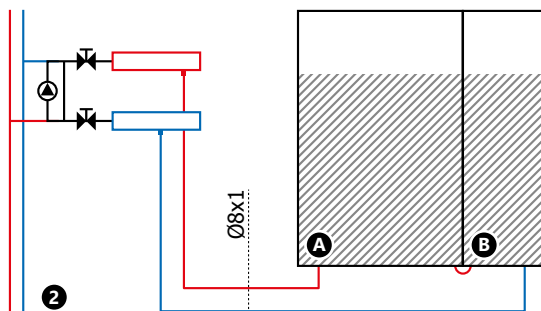

$$30 \leq L1 + L2 + \dots \leq 40 \text{ m}$$

Fig. 2	Area	Size (mm)	Q (W)	L (m)
Board A	75%	2000 × 625	92,5	≈15,6
Board B	75%	2000 × 310	44,5	≈6,4

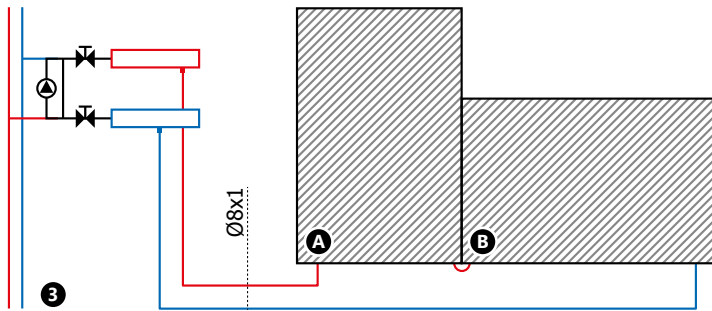

$30 \leq L1 + L2 + \dots \leq 40 \text{ m}$

Fig. 3	Area	Size (mm)	Q (W)	L (m)
Board A	100%	1000 × 625	61,7	≈9,4
Board B	100%	625 × 1250	77,1	≈11,8

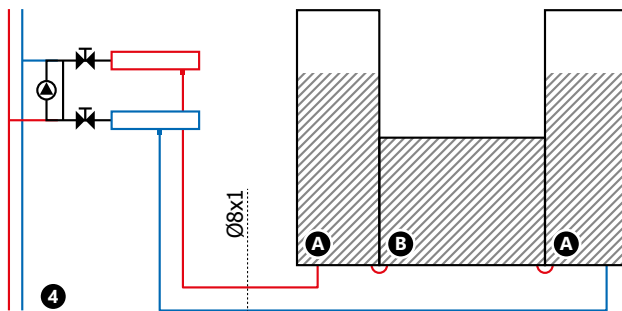

$30 \leq L1 + L2 + \dots \leq 40 \text{ m}$

Fig. 4	Area	Size (mm)	Q (W)	L (m)
Board A	75%	2000 × 310	44,5	≈6,4
Board B	100%	1000 × 625	61,7	≈9,4

- Boards with total nominal power of 1200W can be connected to one Tichelman circuit with splitter. In the case of Tichelman circuit it is recommended to connect single heating boards or sets of heating boards with similar pipe lengths – the lengths of individual boards or board sets cannot differ by more than 10%. To provide an optimal hydraulic adjustment of the system you should attach a set of heating boards with minimum total 8 mm pipe length of 40 m.

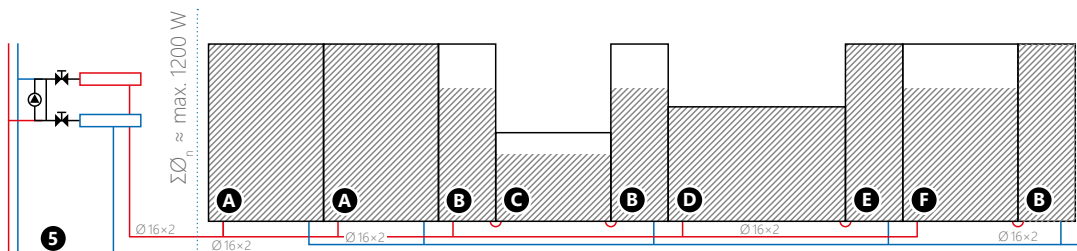

$L1 + L2 + \dots \leq 40 \text{ m}$  (applies to heating boards connected in series)

Fig. 5	Area	Size (mm)	Q (W) 40/35/20°C	L (m)
Board A	100%	2000 × 625	123,4	≈20,4
Board B	75%	2000 × 310	44,5	≈6,4
Board C	75%	1000 × 625	61,7	≈9,4
Board D	100%	625 × 1250	77,1	≈11,8
Board E	100%	2000 × 310	59,3	≈8,3
Board F	75%	2000 × 625	92,5	≈15,6

- The connection of heating&cooling boards of KAN-therm Wall system and connecting them into the Tichelman circuit should be done using special ultraPRESS/Click fittings available in the KAN-therm Wall system offer:



**! Note!**

The ultraPRESS nozzles are made using the LBP technology and the connections can be pressed with jaws with U and TH profile.

### Preparing the system to start-up

#### Flushing, filling and venting

The flushing process should be done right after fixing the active wall boards. At the end of the filling process you should align hydraulically individual bands of pipes or separate heating circuits with direct connection to the heating system splitter.

To remove air bubbles you should ensure the minimum value of volume stream during the venting process. The value is 0,35 l/min, which relates to 0,2 m/s flow rate.

#### Pressure test for tightness

The tightness test should be done after venting the whole heating&cooling system in accordance with the KAN tightness test protocol for surface heating and cooling. When the danger of frost arises, you should take appropriate measures to avoid damaging pipes due to freezing. In such case you can heat the room or use anti-freeze measures.

**! Note!**

Before the start-up of the KAN-therm Wall heating&cooling board system you should vent the pipes and run the tightness test of the whole installation.

## 5 Components of **KAN-therm** radiant heating and cooling

A KAN-therm system comprises all necessary components needed for installation of surface water heating and cooling:

- heating/cooling pipes,
- thermal insulations,
- pipe mounting systems,
- dilatation elements (dilatation tapes and profiles),
- heating circuits manifolds,
- installation cabinets,
- control and automation devices,
- screed additives.



Fig. 44. Components of KAN-therm surface heating/cooling

## 5.1 KAN-therm heating/cooling pipes

KAN-therm system high quality polyethylene pipes with anti-diffusion barrier and multilayer polyethylene pipes for all types of surface heating and cooling.

KAN-therm PERT, PERT<sup>2</sup> and bluePERT pipes are made from acetate copolymer of polyethylene with improved thermal resistance and excellent mechanical properties. Properties of the pipes and the range of their operating conditions correspond with EN ISO 21003-2.

KAN-therm PEXC pipes are made from high density polyethylene subjected to the molecular electron beam crosslinking ("c" method – physical method, no chemicals involved). Such crosslinking of polyethylene structure ensures the most optimum, high resistance to thermal and mechanical loads. Properties of the pipes and the range of their operating conditions correspond with EN ISO 15875-2.

Both types of pipes feature a barrier preventing ingress (diffusion) of oxygen to heating water through pipe walls. The EVOH barrier (ethylene vinyl alcohol) meets the requirements of DIN 4726, (permeability  $<0,10 \text{ g O}_2/\text{m}^3 \times \text{d}$ ).

KAN-therm PERTAL, PERTAL<sup>2</sup> and bluePERTAL pipes comprise of the following layers:

- inner layer of PE-RT polyethylene with improved thermal resistance,
- middle layer of an aluminium, laser butt-welded,
- outer layer of PE-RT polyethylene with improved thermal resistance.

Between aluminium and plastic layers the pipes feature an adhesive binding layer for permanent binding of the metal and plastic material.

Properties of the pipes and the range of their operating conditions correspond with EN ISO 21003-2.

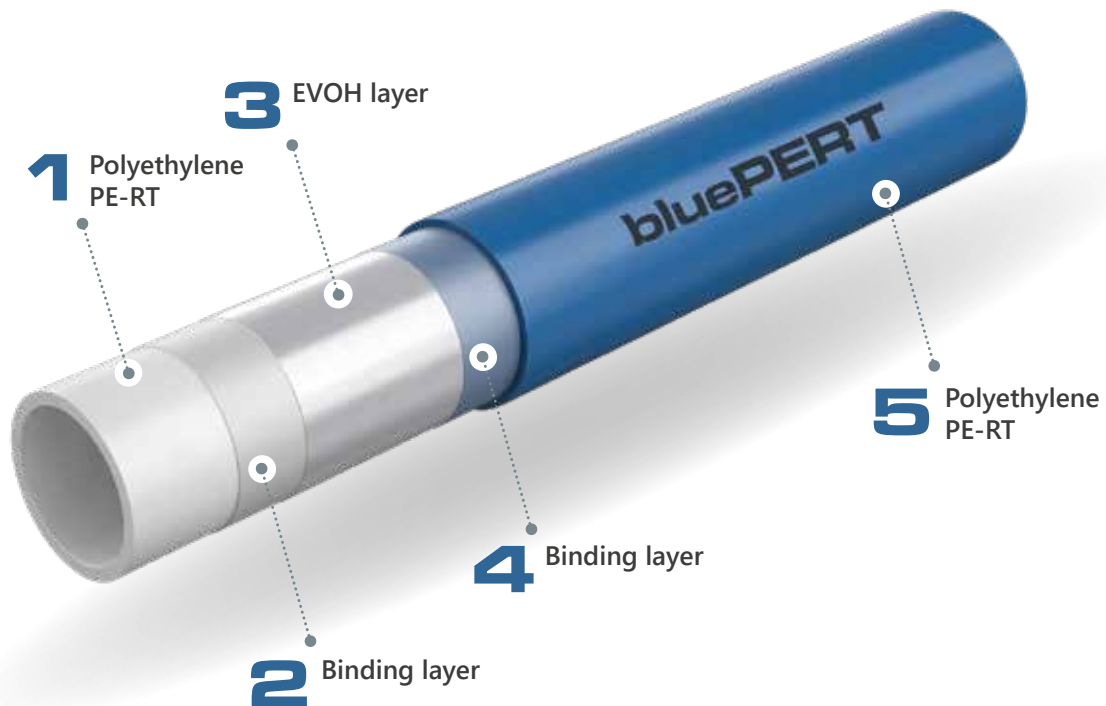

Fig. 45. Design of bluePERT with EVOH layer.

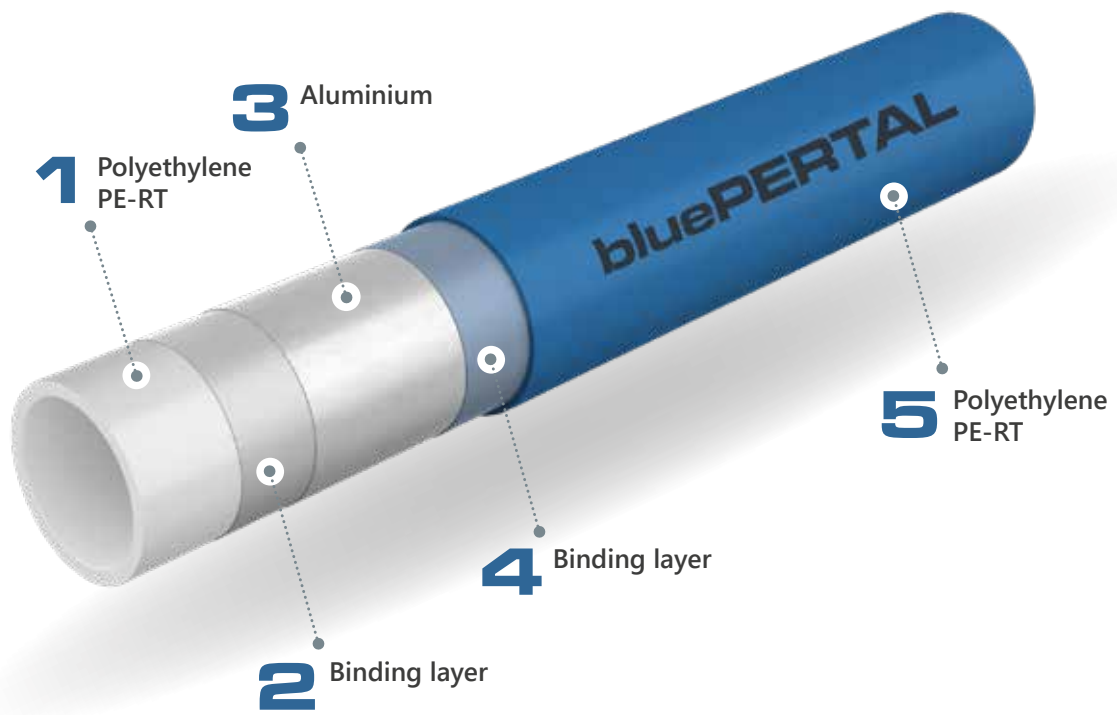

Fig. 46. Design of bluePERTAL with aluminum layer.

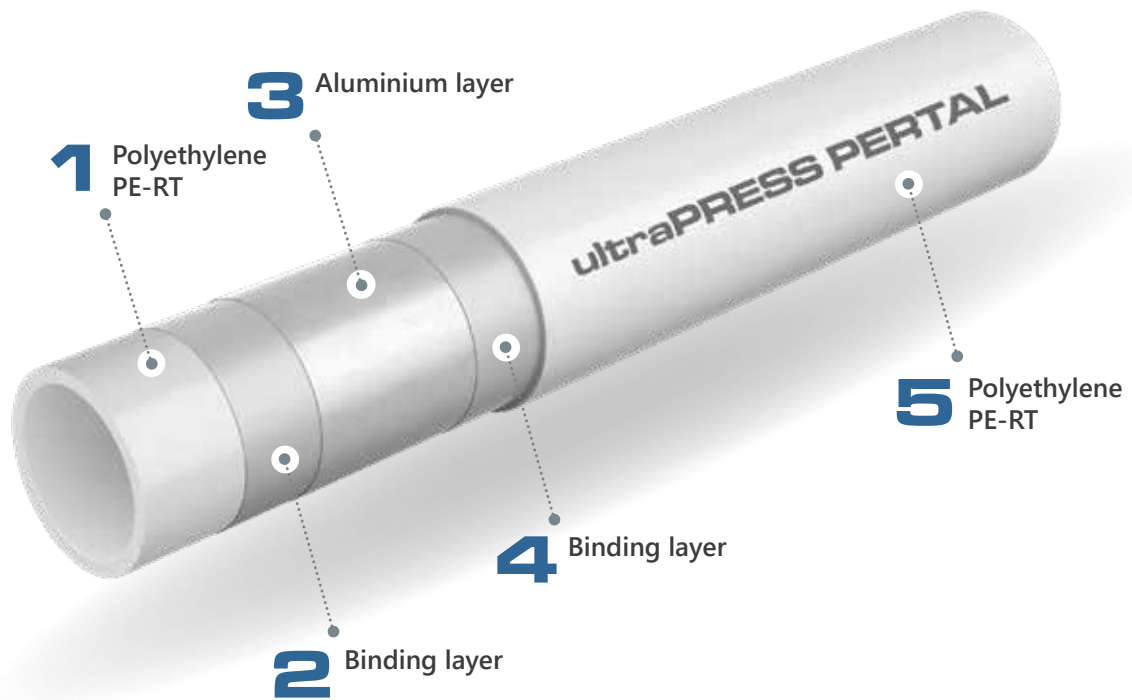

Fig. 47. Design of KAN-therm PERTAL pipe with aluminum layer.

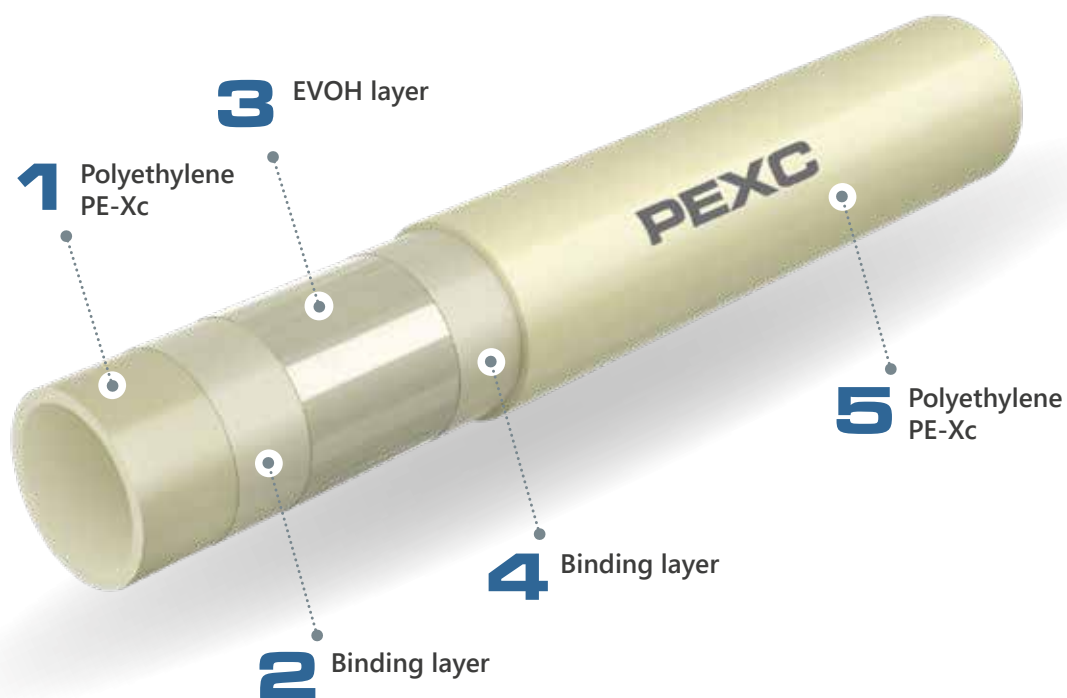

Fig. 48. Design of KAN-therm PEXC pipe with EVOH layer.

## Properties of KAN-therm heating/cooling pipes

Property	Symbol	Unit	PEXC	PERT	bluePERT	PERTAL	bluePERTAL
<b>Linear elongation coefficient</b>	$\alpha$	mm/m × K	0,14 (20 °C) 0,20 (100 °C)	0,18	0,18	0,025	0,025
<b>Heat conductivity</b>	$\lambda$	W/m × K	0,35	0,41	0,41	0,43	0,43
<b>Nominal bending radius</b>	$R_{\mu\text{TV}}$		5 × D	5 × D	5 × D	5 × D 3,5 × D*	5 × D 3,5 × D*
<b>External wall coarseness</b>	k	mm	0,007	0,007	0,007	0,007	0,007
<b>Anti-diffusion barrier</b>			EVOH (< 0,1 g/ m <sup>3</sup> × d)	EVOH (< 0,1 g/ m <sup>3</sup> × d)	EVOH (< 0,1 g/ m <sup>3</sup> × d)	Al	Al
<b>Max. operating conditions</b>	$T_{\mu\text{m}\xi}/P_{\text{max}}$	°C/bar	90/6	90/6	70/6	90/10	70/6

\*with a use of profiling tools

## Parameters of KAN-therm heating/cooling pipes

DN	Outer diameter × wall thickness	Inner diameter	Unit weight	Water volume	Number in one coil	Colour
	mm × mm	mm	kg/m	l/m	m	
<b>KAN-therm PB, PERT, PERT<sup>2</sup>, bluePERT or bluePERTAL pipes</b>						
8	8 × 1,0	6,0	0,023	0,028	600	grey
12	12 × 2,0	8,0	0,071	0,050	80, 200	milky, blue (bluePERT)
14	14 × 2,0	10,0	0,085	0,079	200, 600	milky, blue (bluePERT)
16	16 × 2,0	12,0	0,094	0,113	60, 120, 200, 240, 480, 600	milky, blue (bluePERT, bluePERTAL)
16	16 × 2,2	11,6	0,100	0,106	200	milky
18	18 × 2,0	14,0	0,113	0,154	60, 120, 200, 240, 480, 600	milky, blue (bluePERT)
18	18 × 2,5	13,0	0,125	0,133	200	milky
20	20 × 2,0	16,0	0,172	0,201	200, 300, 600	milky, blue (bluePERT)
20	20 × 2,8	14,4	0,155	0,163	100	milky
25	25 × 2,5	20	0,239	0,314	220	milky, blue (bluePERT)
<b>KAN-therm PEXC pipes</b>						
12	12 × 2,0	8,0	0,071	0,050	200	cream-coloured
14	14 × 2,0	10,0	0,085	0,079	200	cream-coloured
16	16 × 2,0	12,0	0,094	0,113	200	cream-coloured
16	16 × 2,2	11,6	0,102	0,106	200	cream-coloured
18	18 × 2,0	14,0	0,113	0,154	200	cream-coloured
18	18 × 2,5	13,0	0,125	0,133	200	cream-coloured
20	20 × 2,0	16,0	0,141	0,201	200	cream-coloured
20	20 × 2,8	14,4	0,157	0,163	100	cream-coloured
25	25 × 3,5	18,0	0,247	0,254	50	cream-coloured
<b>KAN-therm PERTAL i PERTAL<sup>2</sup> pipes</b>						
14	14 × 2,0	10	0,102	0,079	200	white
16	16 × 2,0	12	0,129	0,113	200	white
16	16 × 2,2	11,6	0,114	0,106	200	white
20	20 × 2,0	16	0,152	0,201	100	white
20	20 × 2,8	14,4	0,180	0,163	100	white
25	25 × 2,5	20	0,239	0,314	50	white

## Heating pipe connections, repairability

As far as practical avoid connecting pipe sections in loops. Never connect pipes on bends. Any damage of already arranged pipes (such as accidental drilling through pipes) can be repaired by removing the damaged section (perpendicularly to pipe axis) and connecting both ends with a clamp connector. To repair a pipe covered with concrete a fairly long groove must be cut out.

Permanent clamp connectors of brass or PPSU plastic are KAN-therm system recommended connections for pipe sections. Depending on the pipe type these could be brass push rings connectors (KAN-therm Push system), connectors with PVDF sleeving sleeve (KAN-therm ultraLINE system) or KAN-therm ultraPRESS steel pressed ring connectors. Temporary connections (twisted) must not be used except when such connector is placed in an inspection hole.



**Fig. 49.** KAN-therm Push connector for PEXC, PERT and bluePERT pipes, diameters 12 × 2, 14 × 2, 18 × 2, 25 × 3,5 mm.



**Fig. 50.** KAN-therm ultraLINE connector for PEXC, PERT<sup>2</sup> and PERTAL<sup>2</sup> pipes, diameters 14 × 2, 16 × 2,2, 20 × 2,8, 25 × 2,5 mm.



**Fig. 51.** KAN-therm ultraPRESS coupling for PERTAL, PEXC, PERT, bluePERT and bluePERTAL pipes 14 × 2, 16 × 2, 20 × 2, 25 × 2,5 mm.

Connections of this type can be located directly in the layers of screed and plaster, without using additional insulation elements. In order to make a correct connection, it is necessary to follow the standard guidelines of KAN for the installation of KAN-therm Push, ultraLINE and ultraPRESS system components.

## 5.2 KAN-therm manifolds

Manifolds are the elements of the system that enable distribution and control of the heating or cooling medium. KAN-therm system offers a wide range of manifolds: from simple solutions with control valves to modern manifolds with flowmeters and valves featuring thermoelectric servomotors.

For smaller floor heating installations (up to several dozen tens m<sup>2</sup>) KAN-therm system has on offer a convenient and cost-effective model of loop manifold combined with pump mixing system. This solution is particularly useful for mixed systems, where low-temperature floor heating system works in combination with radiator heating system, supplied by a source with a temperature of at least 60 °C. KAN-therm also offers independent pumping groups, which can be combined with any KAN-therm system floor heating manifold. For installations that require higher flow rates, especially surface cooling systems, KAN-therm system offers modular plastic manifolds.

All manifolds, made of high quality stainless 1 1/4" profiles, feature connection stubs with 3/4" male thread (Eurocone). Manifolds made of 1 1/4" profile plastic modules are equipped with connection stubs with 3/4" or 1" male threads.

# Installation dimensions of KAN-therm manifolds for radiant heating/cooling systems

## KAN-therm InoxFlow stainless steel for radiant heating/cooling

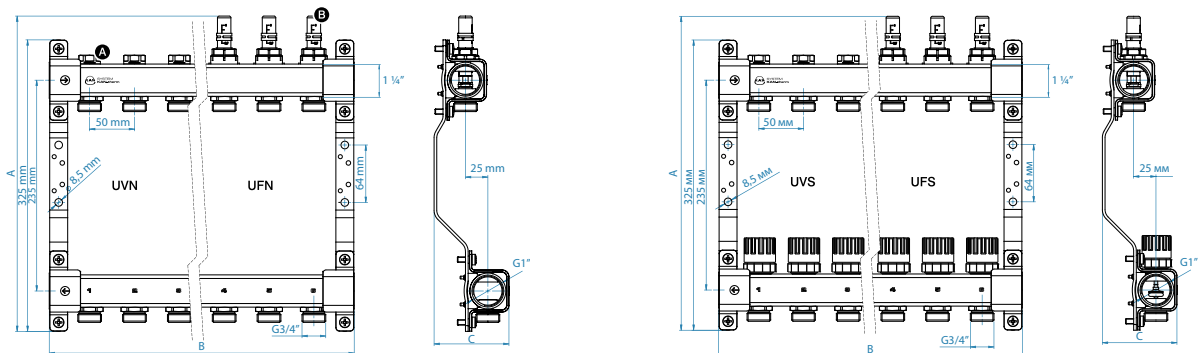

Number of circuits	Series UVN	Series UFN	Series UVS	Series UFS
--------------------	------------	------------	------------	------------

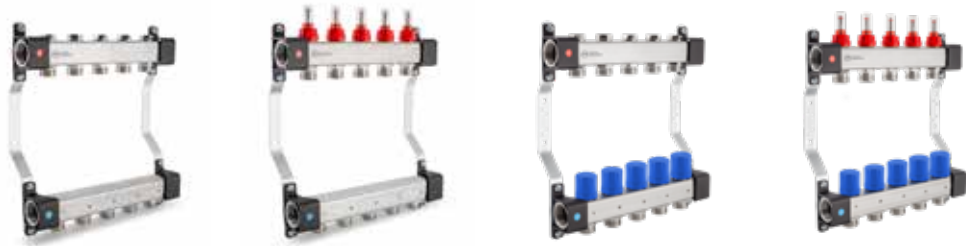

Dimensions (height A × width B × depth C)

Number of circuits	Series UVN	Series UFN	Series UVS	Series UFS
2	325 × 140 × 84	352 × 140 × 84	325 × 140 × 84	352 × 140 × 84
3	325 × 190 × 84	352 × 190 × 84	325 × 190 × 84	352 × 190 × 84
4	325 × 240 × 84	352 × 240 × 84	325 × 240 × 84	352 × 240 × 84
5	325 × 290 × 84	352 × 290 × 84	325 × 290 × 84	352 × 290 × 84
6	325 × 340 × 84	352 × 340 × 84	325 × 340 × 84	352 × 340 × 84
7	325 × 390 × 84	352 × 390 × 84	325 × 390 × 84	352 × 390 × 84
8	325 × 440 × 84	352 × 440 × 84	325 × 440 × 84	352 × 440 × 84
9	325 × 490 × 84	352 × 490 × 84	325 × 490 × 84	352 × 490 × 84
10	325 × 540 × 84	352 × 540 × 84	325 × 540 × 84	352 × 540 × 84
11	325 × 590 × 84	352 × 590 × 84	325 × 590 × 84	352 × 590 × 84
12	325 × 640 × 84	352 × 640 × 84	325 × 640 × 84	352 × 640 × 84

1 1/4" stainless steel profile with 1" female threads  
 Outlets spacing 50 mm  
 Manifold beam spacing 235 mm

**A full set includes:**

- 3/4" male thread outlets, control valves on upper beam, set of mounting brackets with vibration damping insert.
- 3/4" male thread outlets, control and measuring valves (flow meters) on upper beam, set of mounting brackets with vibration damping insert.
- 3/4" male thread outlets, control valves on upper beam, shut-off valves for electric servomotors with caps, set of mounting brackets with vibration damping insert.
- 3/4" male thread outlets, control and measuring valves (flow meters) on upper beam, shut-off valves for electric servomotors with caps, set of mounting brackets with vibration damping insert.

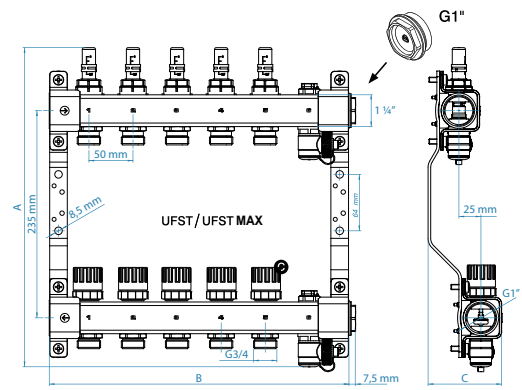
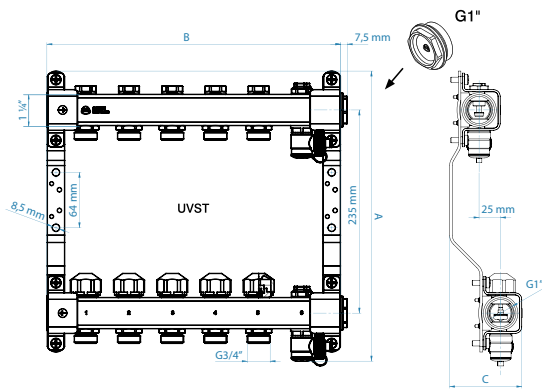

Number of circuits	Series UVST	Series UFST/UFST MAX
--------------------	-------------	----------------------

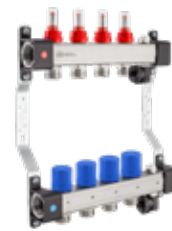

**Dimensions (height A x width B x depth C)**

2	336 x 190 x 84	362 x 190 x 84
3	336 x 240 x 84	362 x 240 x 84
4	336 x 290 x 84	362 x 290 x 84
5	336 x 340 x 84	362 x 340 x 84
6	336 x 390 x 84	362 x 390 x 84
7	336 x 440 x 84	362 x 440 x 84
8	336 x 490 x 84	362 x 490 x 84
9	336 x 540 x 84	362 x 540 x 84
10	336 x 590 x 84	362 x 590 x 84
11	336 x 640 x 84	362 x 640 x 84
12	336 x 690 x 84	362 x 690 x 84

**1 1/4" stainless steel profile with 1" female threads  
Outlets spacing 50 mm  
Manifold beam spacing 235 mm**

**A full set includes:**

- 3/4" male thread outlets,
- control valves on upper beam,
- shut-off valves for electric servomotors with caps,
- set of mounting brackets with vibration damping insert,
- 2 vent and drain valves.

- 3/4" male thread outlets,
- control and measuring valves (flow meters) on upper beam,
- shut-off valves for electric servomotors with caps,
- set of mounting brackets with vibration damping insert,
- 2 vent and drain valves.

## KAN-therm surface heating manifolds with mixing system

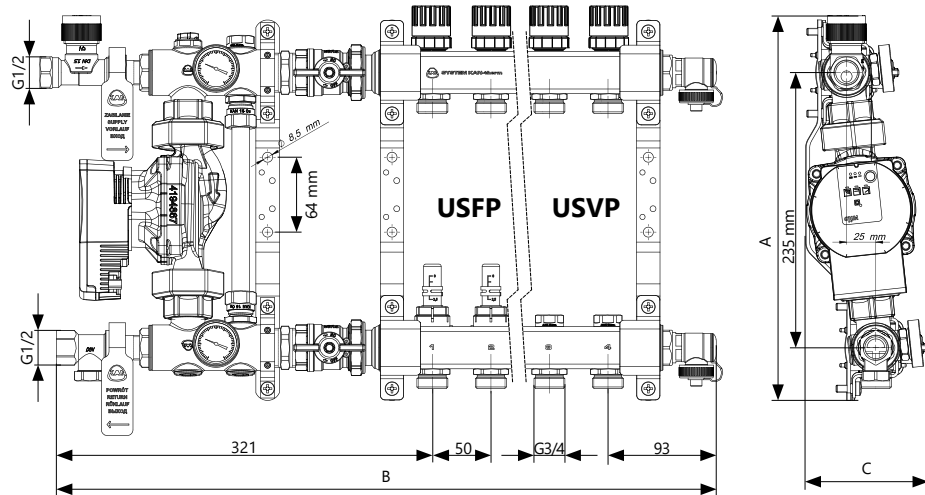

Number of circuits	Series USVP	Series USFP
--------------------	-------------	-------------

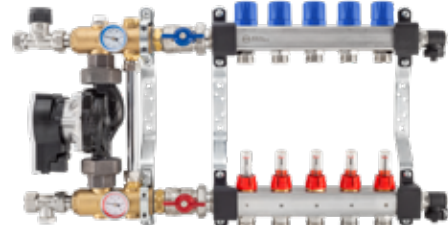

**Dimensions (height A x width B x depth C)**

Number of circuits	Series USVP Dimensions (A x B x C)	Series USFP Dimensions (A x B x C)
2	329 x 478 x 105	329 x 478 x 105
3	329 x 528 x 105	329 x 528 x 105
4	329 x 578 x 105	329 x 578 x 105
5	329 x 628 x 105	329 x 628 x 105
6	329 x 678 x 105	329 x 678 x 105
7	329 x 728 x 105	329 x 728 x 105
8	329 x 778 x 105	329 x 778 x 105
9	329 x 828 x 105	329 x 828 x 105
10	329 x 878 x 105	329 x 878 x 105

**1 1/4" stainless steel profile with 1" female threads  
Outlets spacing 50 mm  
Manifold beam spacing 235 mm**

**A full set includes:**

- 3/4" male thread outlets,
- control valves on bottom beam,
- shut-off valves for electric servomotors with caps,
- 2 vent and drain valves,
- set of mounting brackets with vibration damping insert.

- 2x 1" shut-off valves,
- 1/2" thermostatic valve,
- 1/2" control valve,
- 2 dial thermometers,
- by-pass with control valve,
- glandless electronic pump Wilo Para 25/6.

- 3/4" male thread outlets,
- control and measuring valves (flow meters) on bottom beam,
- shut-off valves for electric servomotors with caps,
- 2 vent and drain valves,
- set of mounting brackets with vibration damping insert.

## KAN-therm plastic manifolds for surface heating/cooling

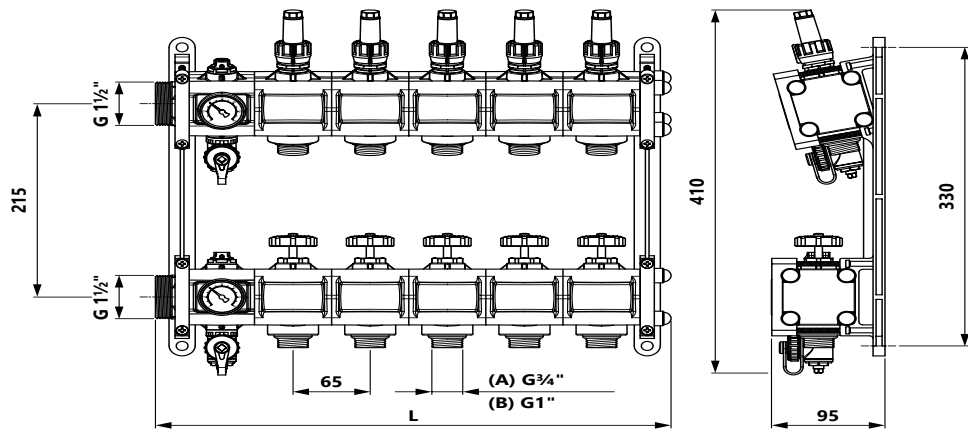

Number of circuits	Version (A) 1 1/2" x 3/4"	Version (B) 1 1/2" x 1"
--------------------	---------------------------	-------------------------



Dimension (height A x width B x depth C)

2	410 x 240 x 95
3	410 x 305 x 95
4	410 x 370 x 95
5	410 x 435 x 95
6	410 x 500 x 95
7	410 x 565 x 95
8	410 x 630 x 95
9	410 x 695 x 95
10	410 x 760 x 95
11	410 x 825 x 95
12	410 x 890 x 95
13	410 x 955 x 95
14	410 x 1020 x 95
15	410 x 1085 x 95
16	410 x 1150 x 95

**1 1/2" plastic profile 1 1/2" male threads**  
**Outlets spacing 65 mm**  
**Manifold beam spacing 215 mm**

<b>A full set includes</b>	<ul style="list-style-type: none"> <li>- 3/4" male thread outlets;</li> <li>- control and measuring valves (flowmeters) on upper beam</li> <li>- shut-off valves</li> <li>- 2 vent and drain valves</li> <li>- 2 thermometers</li> </ul>	<ul style="list-style-type: none"> <li>- 1" male thread outlets;</li> <li>- control and measuring valves (flowmeters) on upper beam</li> <li>- shut-off valves</li> <li>- 2 vent and drain valves</li> <li>- 2 thermometers</li> </ul>
----------------------------	--	--

The KAN-therm surface heating and cooling range also includes individual modules for the completion of the plastic manifold. The thermostatic module enables the cooperation of surface heating systems with automation control.

KAN-therm system manifold offer includes also a wide range of accessories: plugs and adapters as well as manifold beam extension pieces, straight and angular connection valves, vents and drain valves, electric servomotors as well as pipe joints for connecting of the pipes.



**Discriptions and manuals of manifolds are available in separate brochures at [en.kan-therm.com](http://en.kan-therm.com).  
InoxFlow UVN, UFN, UVS, UVST, UFS, UFST, UFST MAX series manifold instruction manual  
InoxFlow USVP i USFP series manifold instruction manual,  
Plastic manifold - instruction manual**

## **KAN-therm mixing systems**

Radiant heating requires lower supply temperature than radiator heating. The maximum temperature of supplying water should not exceed 55 °C. Therefore, in case of a common heating thermal source with radiators, the solutions, which lower the temperature of power supply, should be applied. The systems based on mixing the heating water flowing from the heating source with surface heating installation return water are available in KAN-therm system.

KAN-therm surface heating can also be directly supplied from low-temperature heat sources, such as condensing boilers or heat pumps.

## **KAN-therm local mixing systems**

KAN-therm local mixing systems are applied in high-temperature installations (radiator) when there is a need to ensure a heating medium of lower parameters for a coil unit, supported by a single manifold. Lowering the supply temperature to the values proper for surface heatings takes place on the basis of pumping mixing. It is a system of constant temperature, implemented through quantity adjustment. Such system is not suitable for low temperature heating sources (below 60 °C).

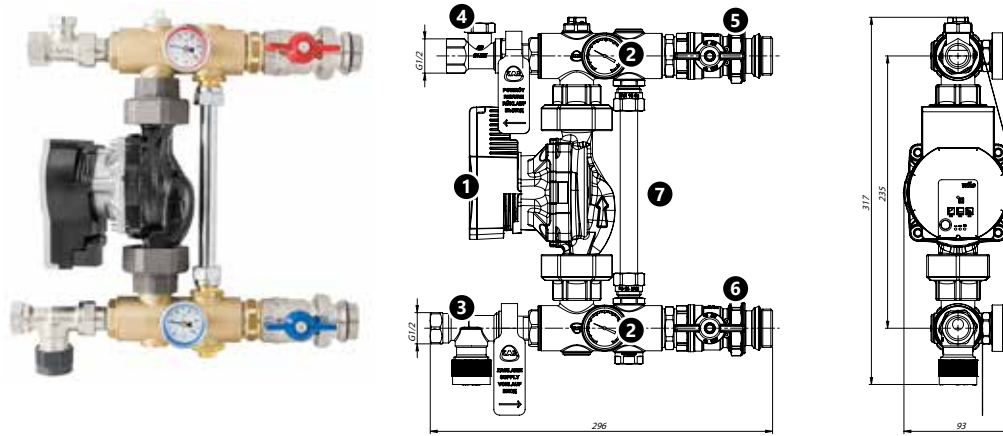

**Fig. 52.** KAN-therm pump unit design.

1. glandless electronic pump Wilo PARA 25/6
2. dial thermometers
3. ZT female thread 1/2" thermostatic valve
4. ZR female thread 1/2" control valve
5. G1" cut-off valve of the supplying beam
6. G1" cut-off valve of the return beam
7. by-pass with control valve

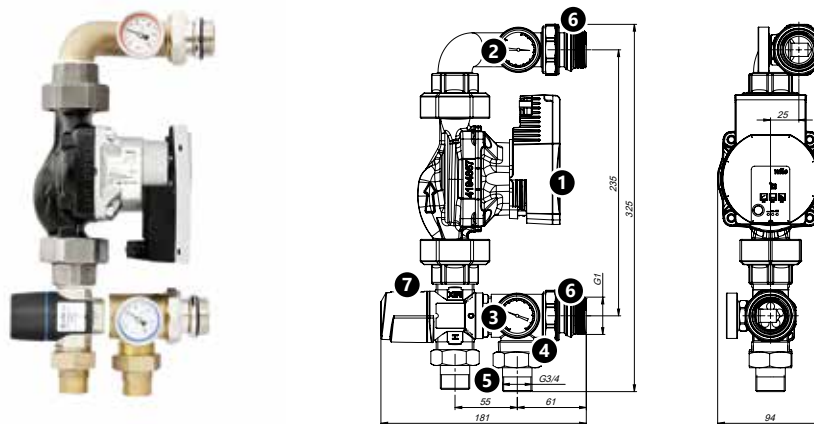
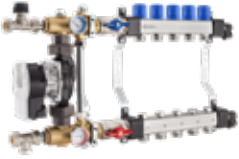
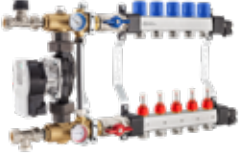



**Fig. 53.** Construction of mixing unit with 3-way thermostatic valve KAN-therm.

1. glandless electronic pump Wilo PARA 25/6
2. dial thermometers – supply
3. dial thermometers – return
4. return from the mixing unit with G 1" male thread
5. G 1" × G 3/4" union connectors
6. G 1" male union connectors for manifold attachment
7. 3-way mixing thermostatic valve Afriso ATM 363 or ATM 561 with G 1" male connections.

Construction, mounting, start-up and operation of individual mixing systems versions are included in the manuals. The manuals contain charts with pump and ZR control valve properties.

**Tab. 1. KAN-therm pump mixing systems properties**

Mixing set type	Pump	Manifold
Pump group with a USVP series manifold 	Wilo-Yonos PARA electronic pump 2,5 m <sup>3</sup> /h – 6 m	included in the set, 2–10 circuits with control valves. Included in the set 2 drain valves
Pump group with a USFP series manifold 	Wilo-Yonos PARA electronic pump 2,5 m <sup>3</sup> /h – 6 m	included in the set, 2–10 circuits with control valves. Included in the set 2 drain valves
Constant value mixing unit 	Wilo-Yonos PARA electronic pump 2,5 m <sup>3</sup> /h – 6 m	—
All versions include: glandless pump, thermostatic inlet valve G ½", return balancing valve G ½", by-pass with its balancing valve, connection ball-valves G 1" for manifold attachment, inlet and outlet thermometers.		
Pump group with a three-way mixing valve 	Wilo-Yonos PARA electronic pump 2,5 m <sup>3</sup> /h – 6 m	—
Unit contains glandless pump, 3-way mixing thermostatic valve, G 1" union connectors, thermometers.		

### KAN-therm local pump mixing system operation

The system operates on the principle of mixing heating water from the heating source with the water from loops return. The mixing pump directs some water, which has the temperature proper for surface heating, to the loops supplying manifold, and some, through the ZR control valve, to the system supplying installation return pipeline. The proper degree of water mixing is achieved by adjusting the ZR control valve.

Before mixing, the water supplied to the system flows through ZT thermostatic valve, which can be controlled by a heading with contact sensor, placed on loops supplying manifold beam. The valve makes it possible to set a fixed temperature and protect against overheating (it makes it impossible to supply on surface heating higher temperature than adjusted).

The adjustment of surface heater power is made through, located at the manifold's beam, thermostatic valves, controlled by electric actuators, connected with room thermostats.

Embedded in the by-pass set with a control valve, protects the pump in case of simultaneous closing of all valves on the supplying manifold and cutting off of all loops (e.g. at simultaneous closing of all actuators on manifold thermostatic valves).

Those systems shall not function properly with low-temperature heating sources, e.g. condensing boilers. The minimum required supply temperature of the system (in order to ensure an appropriate temperature of the water after mixing) is 60 °C. For this reason, we recommend using mixing systems based on three-way thermostatic valves to operate with low-temperature heating sources.

Constant value pump groups as well as manifolds with an integrated mixing unit, series: USFP and USVP enable operation in surface heating systems up to 10 circuits (maximum heat load up to 15 kW).

**!** **Note**

Connection places of supply and return pipelines to the mixing units of USFP and USVP series are different than connections for constant pump group series (connection places and flow directions are presented on the diagrams).

**Operation of the pump group with a thermostatic three-way valve**

The system is supplied with hot water from the installation through a three-way thermostatic valve, and from the return of the underfloor heating loops (return beam), thanks to which the mixing and lowering of the temperature of water supplied to the manifold supply beam (supplying the underfloor heating loops) takes place. Water circulation is obtained by the pump.

The water returns to the system through the right outlet.

The appropriate temperature of the medium after mixing is obtained by changing the setting on the three-way thermostatic valve.

If electric servomotors are installed on all loop circuits, the automatic control unit should be equipped with a module that turns off the pump when all circuits are closed. Alternatively, one manifold circuit can be left without automatic control. This will protect the pump against pumping water into a closed system.

**!** **Pay attention to the correct integration of the system into the rest of the installation. The mixing valve should be connected to the supply pipeline. In the case of extended installations, it may be necessary to apply an additional throttle valve at the inlet to the pump group.**

**Adjustment of the thermostatic mixing valve**

In order to set the desired temperature after mixing, remove the plastic protective cap of the three-way valve (snap fastening) and select the appropriate valve setting:

Setting	Water temperature after mixing ATM 363	Water temperature after mixing ATM 361 and ATM 561
1	35 °C	20 °C
2	44 °C	25 °C
3	48 °C	30 °C
4	51 °C	34 °C
5	57 °C	38 °C
6	60 °C	43 °C

Temperature values are given with an accuracy of  $\pm 2$  °C.

The hydraulic characteristics of the valve are shown in the diagram below:

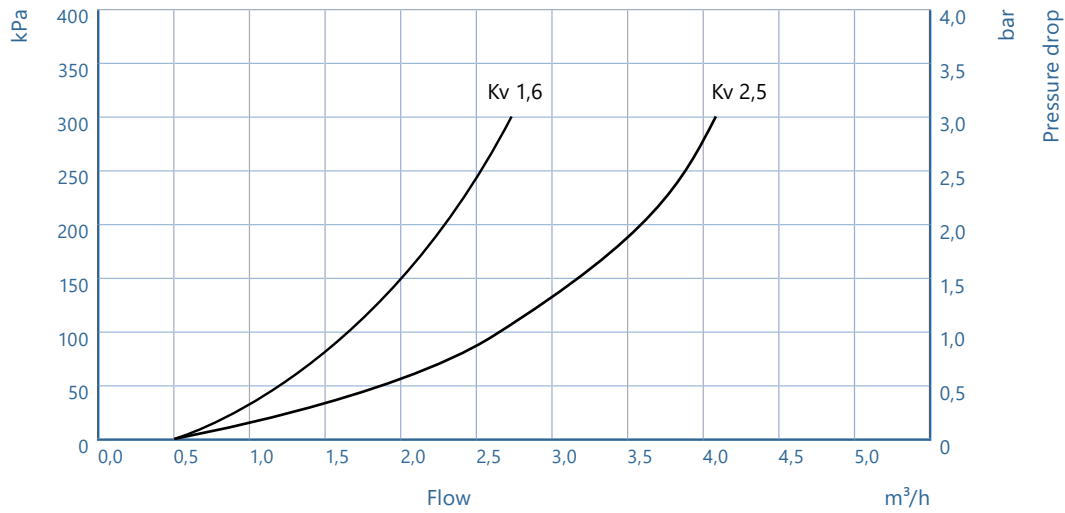

Pump groups of this type are delivered with three-way thermostatic valves with two different Kv values (1,6 and 2,5). Pump groups with a three-way thermostatic valve with Kv = 1,6 should be used for smaller systems (up to 6 heating circuits with a thermal power load up to 7,5 kW).

Pump groups with a three-way thermostatic valve with Kv = 2,5 can be used with larger systems (up to 12 heating circuits with a thermal power load of up to 15 kW).

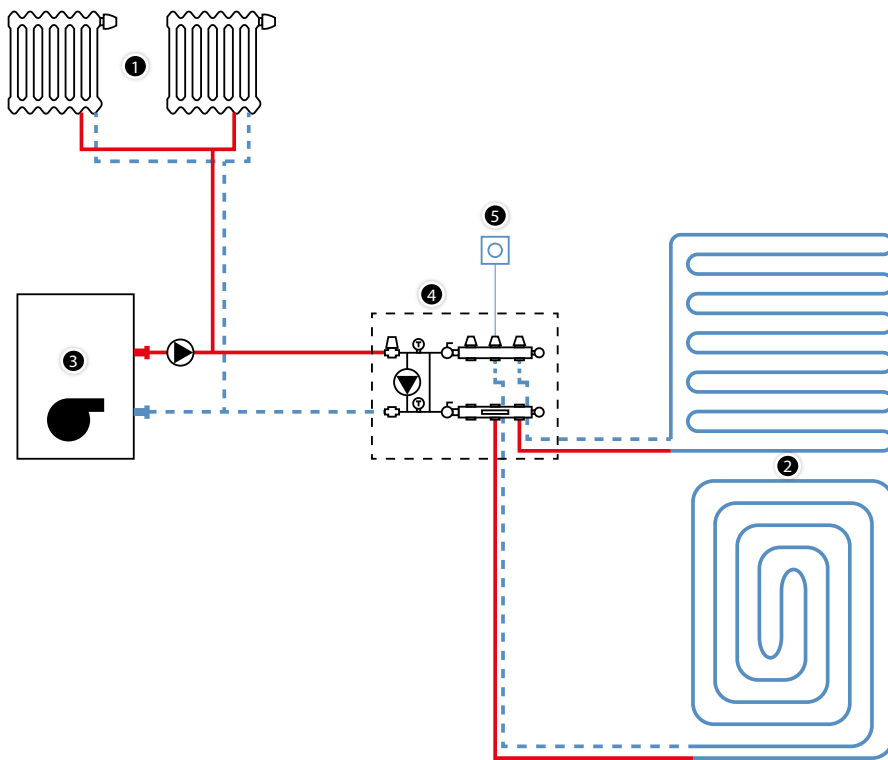

**Fig. 54.** Local mixing system

- 1. High-temperature heating
- 2. Floor/wall heating
- 3. Heat source
- 4. KAN-therm mixing system, pump, with a control valve with thermostatic head with capillary and contact sensor
- 5. Room thermostats

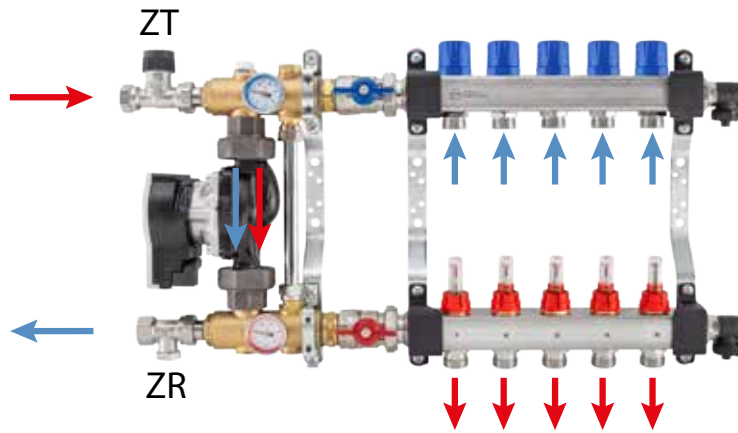

Fig. 55. Manifold provided with USFP with mixing unit system – flow directions.

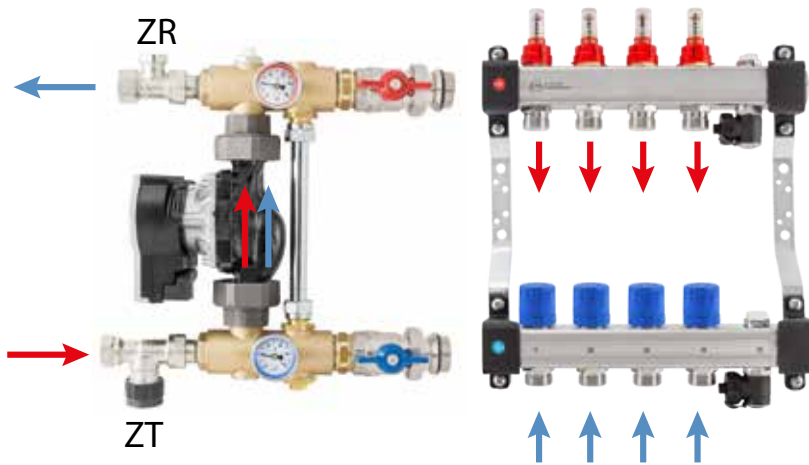

Fig. 56. Constant-value pump group with UFST manifold – flow directions.

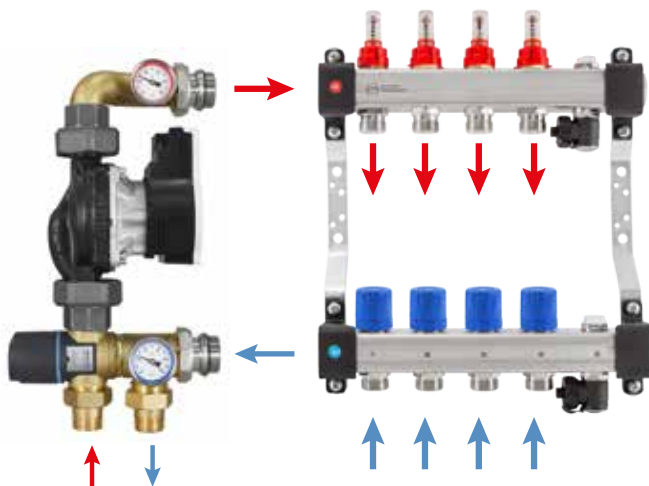

Fig. 57. Pump group with three-way valve with UFST manifold – flow directions.

## 5.3 KAN-therm installation cabinets

Manifolds for surface heating/cooling should be installed in special installation cabinets, which are available in the surface-mounted and recess-mounted versions, as well as in the Slim+ recess-mounted frameless version.





The design of the cabinets for surface heating/cooling applications allows the installation of manifolds with and without a mixing system. The cabinets also provide space for automation controls system devices (e.g. terminal blocks). They can be fixed onto special rail using a screws or by hooking onto a standard DIN rail. Both rails, depending on the type of installation cabinet, are located in the upper part of their construction.

KAN-therm system recess-mounted cabinets have the option of adjusting both the height above the floor level and the depth of the cabinet.

Please note that in the case of installing manifolds with a mixing unit, the required cabinet depth > 120 mm.

Dimensions and selection of cabinets based on the type of manifold, basic accessories and the method of connection can be found in the next table.

**Tab. 2. Selection of installation cabinets for surface heating/cooling depending on manifold type and basic equipment**

	Cabinet type	Code	InoxFlow manifold (max. number of outlets)					
			STD	KPL	OPT	+GP H	KPL +GP 3D	OPT +GP 3D
	<b>Slim+ 450</b>	<b>1414183018</b>	7	2	4	x	x	x
	<b>Slim+ 550</b>	<b>1414183019</b>	9	4	6	x	3	2
	<b>Slim+ 700</b>	<b>1414183020</b>	12	7	9	4	6	5
	<b>Slim+ 850</b>	<b>1414183021</b>	12	10	12	7	9	8
	<b>Slim+ 1000</b>	<b>1414183022</b>	12	12	12	10	12	11
	<b>Slim+ 1200</b>	<b>1414183023</b>	12	12	12	12	12	12
	<b>SWP-OP 10/3</b>	<b>1446117003</b>	9	5	6	x	4	3
	<b>SWP-OP 13/7</b>	<b>1446117004</b>	12	9	10	5	8	7
	<b>SWP-OP 15/10</b>	<b>1446117005</b>	12	12	12	8	11	10
	<b>SWN-OP 10/3</b>	<b>1446180000</b>	9	5	6	x	4	3
	<b>SWN-OP 13/7</b>	<b>1446180001</b>	12	9	10	5	8	7
	<b>SWN-OP 15/10</b>	<b>1446180002</b>	12	12	12	8	11	10

**STD** – Manifold without additional accessories, closed from one side with stop end 1".

**KPL** – Manifold with SET-K valves and air vent and drain valve on bar R5541.

**+GP H** – Manifold with integrated constant value mixing unit.

**KPL +GP 3D** – Manifold with air vent and drain valve on bar and connected pump mixing group with three-way thermostatic valve.

**OPT** – Manifold with integrated air vent and drain group and SET-K valves.

**OPT +GP 3D** – Manifold with integrated air vent and drain group and connected pump mixing group with three-way thermostatic valve.

**Slim+**

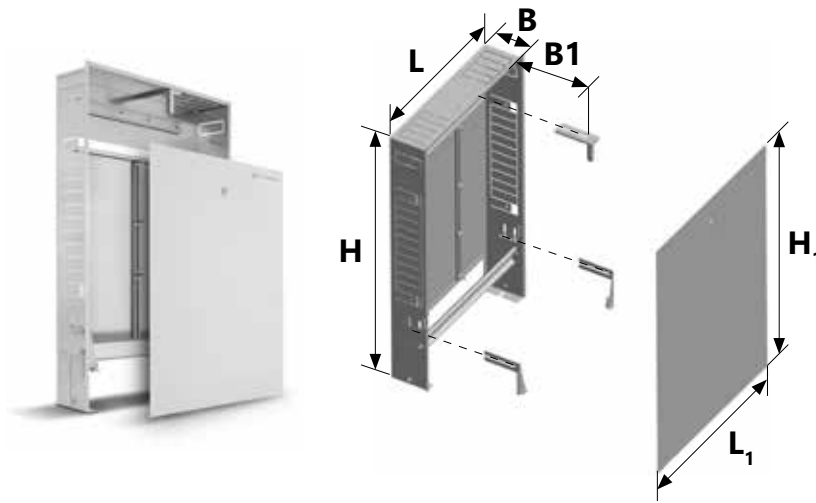

**SWP-OP**

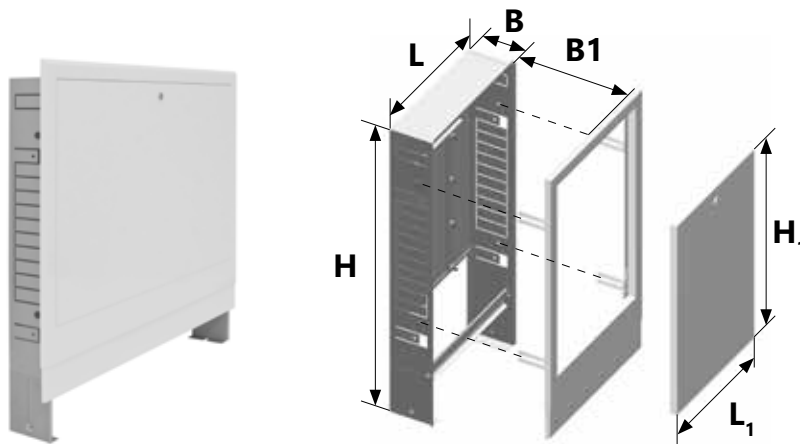

SWN-OP

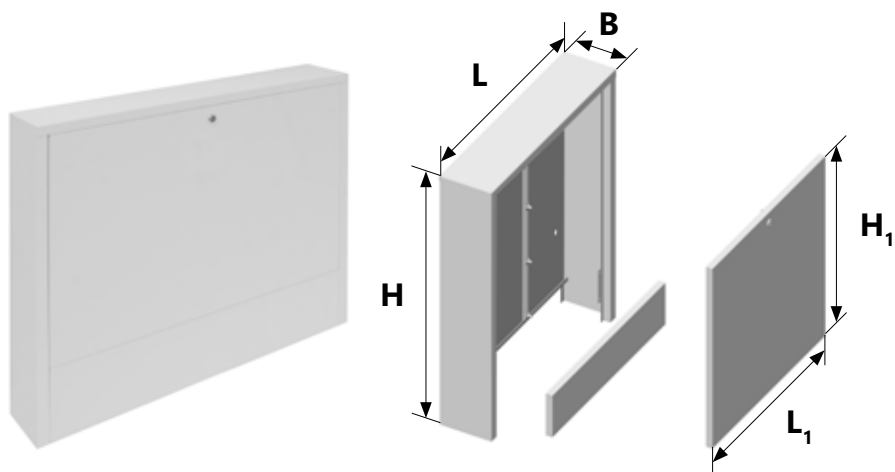

Type	Dimension [mm]						
	L	H	B	L1	H1	B1	
<b>Slim+ 450</b>	450			518			
<b>Slim+ 550</b>	550			618			
<b>Slim+</b>	<b>Slim+ 700</b>	700		768			
	<b>Slim+ 850</b>	850	750-850	918	785-915	112-162	
	<b>Slim+ 1000</b>	1000		1068			
	<b>Slim+ 1200</b>	1200		1268			
<b>SWP-OP</b>	<b>1300-OP</b>	580		569			
	<b>1310-OP</b>	780	750-850	110	769	504	0-50
	<b>1320-OP</b>	930			919		
<b>SWN-OP</b>	<b>1100-OP</b>	580		527			
	<b>1110-OP</b>	780	710	140	727	514	-
	<b>1120-OP</b>	930			877		

## 5.4 Pipe mounting systems in KAN-therm surface heating/cooling

KAN-therm system features a wide choice of pipes connection methods that help to implement various types of surface heating/cooling installations, performed using both by the wet and the dry method.

### KAN-therm Tacker system

Pipes are fastened directly (manually or with a dedicated tool) to KAN-therm Tacker thermal insulation using plastic clips – Tackers (two versions - aluminium and plastic). The top layer of insulation is reinforced with a composite film layer to ensure better grip of clips and to separate the insulation from the screed layer. The system is used in the wet method.



#### Fastening elements

- clips for mounting pipes of 14–18 mm and 20 mm diameter.

### KAN-therm Rail system

Pipes are placed in profiled plastic rails (spaced every 5 cm). Rails are attached to the insulation layer by means of pins or dowels to the building partition (in case of wall heating). For insulation use KAN-therm Tracker system insulation boards with metallised or laminated foil. Rail strip used in the wet and dry (heating of joist floors). Rails are also used for mounting pipes in heating/cooling systems for outdoor surfaces (by mounting the strips to the ground substrate).

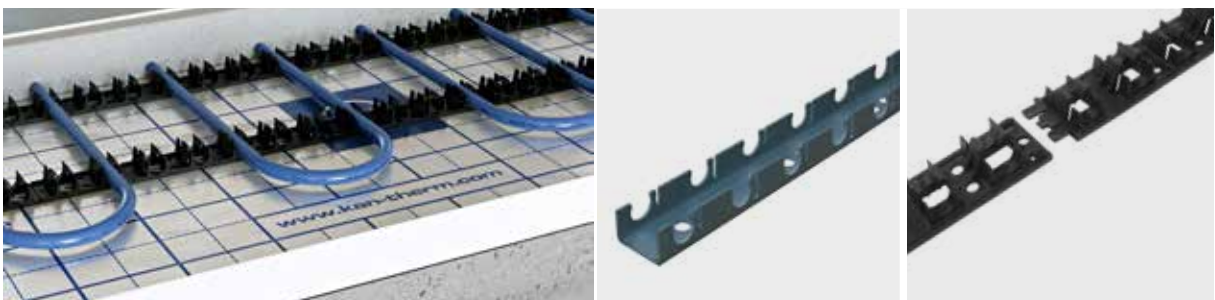

#### Fastening elements

- plastic rails for pipes with diameters of:
  - 16 mm - 2 m long
  - 18 mm - 2 m long
  - 20 mm - 2 m long
- Plastic modular rails for pipes with diameters of:
  - 12–17 mm - 0,2 m long
  - 16–17 mm - 0,5 m long
  - 12–22 mm - 0,5 m long
  - 25 mm - 0,5 m long

## KAN-therm Profil system

Pipes are placed, by pressing, between special tabs, profiled on the thermal insulation (KAN-therm Profil system styrofoam sheets).



## KAN-therm TBS system

Pipes are placed in profiled, grooved insulation boards that are covered with dry screed flooring. The heat from the heating pipes is evenly radiated to the dry screed boards through steel radiating lamellae, placed in the board channels.

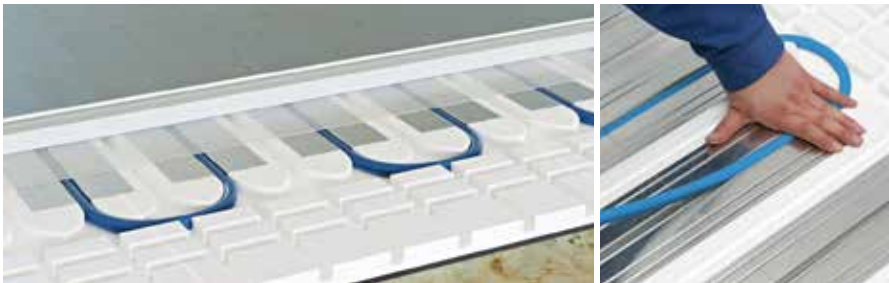

## KAN-therm NET system

Heating and cooling pipe loops are mounted on a net (grid made of 3 mm steel wire) laid on the insulation, using plastic bands or holders laced on the grid (holders are used for 16, 18 and 20 mm diameter pipes). Holders provide 17 mm gap between the pipes and insulation. The NET grid is 1,2 m x 2,1 m in dimension with 150 x 150 mm mesh. Grids are connected together using wire lacing.

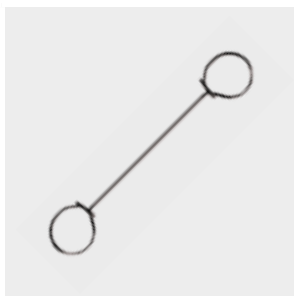
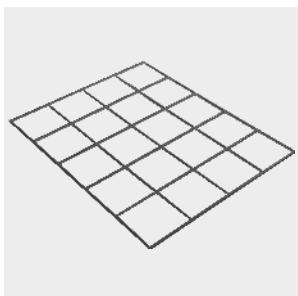

Tab. 3. Range of application of individual pipe mounting systems

System	Outer pipe diameters [mm]	Pipe spacing/pitch [cm]	Insulation	Pipe arrangement	Methods
<b>KAN-therm Tacker</b>	14, 16, 18, 20	10–30/5	KAN-therm Profil styrofoam sheets	series pattern, spiral pattern	wet
<b>KAN-therm Profil</b>	16, 18	5–30/5	KAN-therm Profil styrofoam sheets	series pattern, spiral pattern	wet
<b>KAN-therm Rail</b>	12, 14, 16, 18, 20, 25, 26, 32	10–30/5	KAN-therm Tracker styrofoam sheets or without insulation (wall heating, external surfaces)	series pattern, spiral pattern	wet or dry, pipes mounted on ground substrate
<b>KAN-therm TBS</b>	16	16,7, 25, 33,3	KAN-therm TBS styrofoam sheets with metal lamellae	series pattern of pipes	dry
<b>KAN-therm NET</b>	16, 18, 20, 25, 26	dowolny	KAN-therm Tracker styrofoam sheets or EPS standard styrofoam sheets + damp-proof foil. No insulation for monolithic structures or outdoor surfaces.	series pattern, spiral pattern	wet

Irrespective of the pipe mounting system used, while changing pipe direction be aware of the permissible bending radius of the pipe.

## 5.5 Dilatation tapes and profiles

KAN-therm system offers a full range of proven, professional solutions for the correct execution of heating surfaces dilatation and their separation from building partitions and building structural elements.

### KAN-therm wall tapes

Made of polyethylene foam with 8 mm thick and 150 mm high, to be arranged along aisles, pillars, at the edge of heating plate. Effective dilatation for floor thermal movements, also feature as thermal insulation, reduce heat losses through walls. Notched to adjust the height after laying the concrete slab. Tapes with apron prevent penetration of liquid screed underneath thermal insulation.

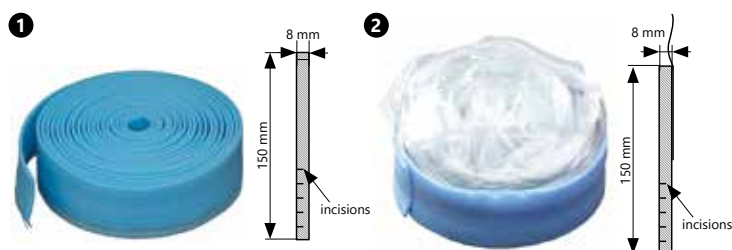

1. Wall tape with incision.
2. Wall tape with incision and with skirt.

### KAN-therm Profil dilatation profiles

To be mounted in dilatation gaps provided during installation. Also available notched tapes of polyethylene foam and dimension of 10 × 150 mm. Transit coil pipes passing through profiles should be placed in casing pipes (conduit) 0,4 m long. Profile sets, comprising PE dilatation tape, mounting rail and casing pipe sections also available.



## 5.6 Other elements

### Concrete additives BETOKAN and BETOKAN Plus

Used to improve workability and strength properties of screed flooring and to increase their thermal conductivity. Available in packs of 5 and 10 kg (BETOKAN) and 10 kg BETOKAN Plus. BETOKAN Plus helps to reduce the thickness of concrete slab above insulation (6,5 cm) to 4,5 cm.



See chapter "Surface heater design – Cement screed" for tips on using concrete additives.

### Fiberglass grid for reinforcement of floors

Used for reinforcement of concrete slabs. Delivered in rolls of 1 × 50 m. Grid thickness 1,7 mm, mesh size of 13 × 13 mm. Used in combination with BETOKAN or BETOKAN Plus concrete plasticizers to increase flexibility of flooring and as the ideal protection against formation of cracks and faults.



## 6 KAN-therm automation controls

### 6.1 General information

Water radiant heating/cooling systems feature large heating inertia and relatively low supply temperature. Those factors determine the means of systems control. The purpose of heating or cooling systems adjustment is to ensure thermal comfort in the rooms while optimising the utilization of energy (heat or cold).

In order to maintain the above mentioned requirements in changing environmental conditions (change of external temperature, insolation, changes in the method of use), the parameters of water supplying the coils should be properly controlled – its temperature (quality adjustment) or its flow (quantity adjustment). The adjustment can be done manually or in automatic mode, using proper sensors, regulators and drivers.

The temperature in the rooms can be controlled centrally, at the level of heat/cooling source (boiler or a system supplying heat or coolness to surface installation throughout facility). The temperature may also be individually adjusted in each room through thermostatic valves with servomotors, placed on heating circuits manifolds (local adjustment). The best effect for comfort and energy saving is achieved through connection of local and central adjustment, which reacts to the external temperature.

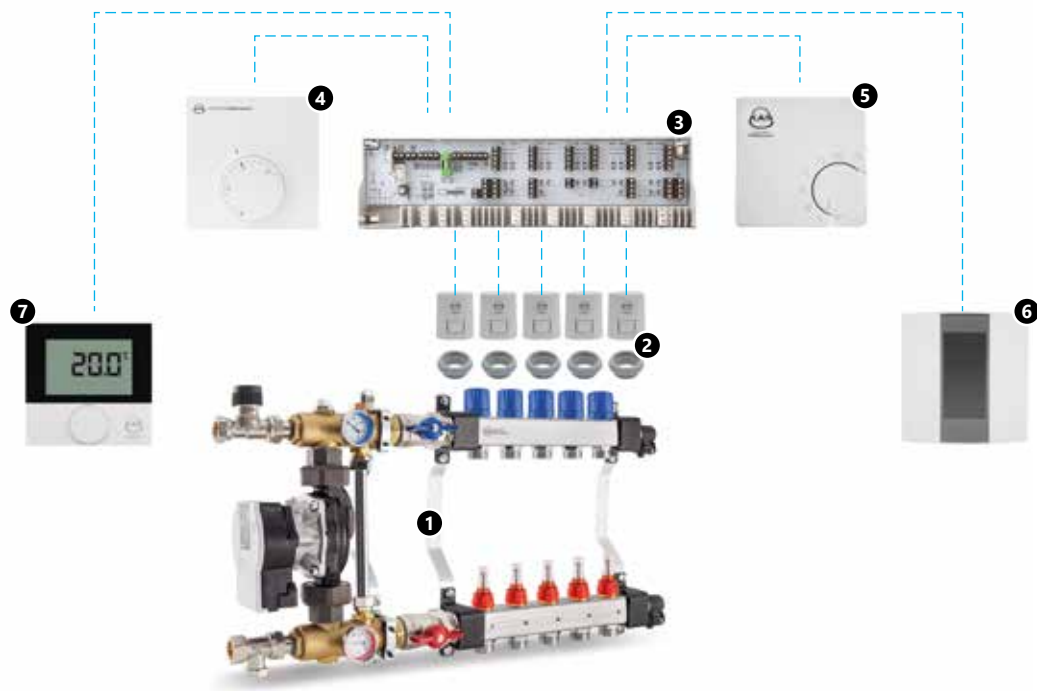

Fig. 58. Example configuration of local, wired KAN-therm surface heating automatics

1. KAN-therm manifold with a mixing unit
2. KAN-therm electric servomotors with their assembly adapters
3. Basic+ 230 V electrical terminal block
4. Basic+ 230 V electronic thermostat
5. Basic+ 24 V/230 V bimetallic thermostat
6. 230 V week electric thermostat
7. Basic+ 230 V or 24 V heating/cooling room thermostat with LCD.

The operation of adjustment devices supports, typical for radiant systems, self-adjustment effect. Self-adjustment properties are due to relatively small temperature differences  $\Delta t$  between the temperature of heating surface (floor, wall) and the temperature in the room. Even small change of air temperature in the room causes significant (in comparison with high-temperature radiators) change of temperature difference  $\Delta t$ , which determines the level of heat flux given off by a heating surface. If in a room, due to periodic insolation, the air temperature increases by 1 °C (from 20 to 21), the heat flux given off by the floor of surface temperature 23 °C shall decrease by 1/3.

## 6.2 Adjustment and automation elements

KAN-therm system offers a vast variety of modern devices that allow for supplying heating to coils of the medium of proper parameters and efficient control of surface heating/cooling systems, both in manual and automatic mode. Adjustment systems are available in 230 V or 24 V cable versions.

### KAN-therm thermostats and regulators

KAN-therm system provides a wide variety of room thermostats and more complex week regulators. Those devices are available in 230 V and 24 V versions. 24 V devices should be applied in the places, where safe voltage is required (e.g. rooms of high humidity), as well as in buildings, in which the electric installation is not equipped with shock protection.

#### KAN-therm cable thermostats

##### 230 V/24 V bimetallic room thermostat

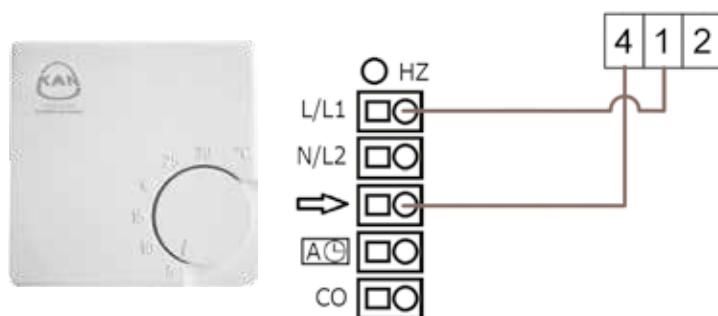

Fig. 59. Clamps and 24 V–230 V bimetallic thermostat connection to the Basic+ electrical terminal block diagram.

Bimetallic room thermostat is responsible for controlling executive elements – electric actuators in KAN-therm surface heating and allows for individual adjustment of temperature in room. The thermostat can be mounted over flush-mounted box or directly on a wall. The device can operate in both 24 V and 230 V installation.

##### Temperature sensor with hidden pre-set Basic+ 230 V or 24 V

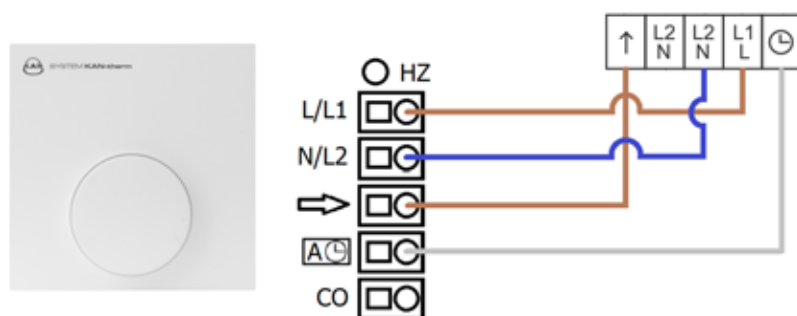
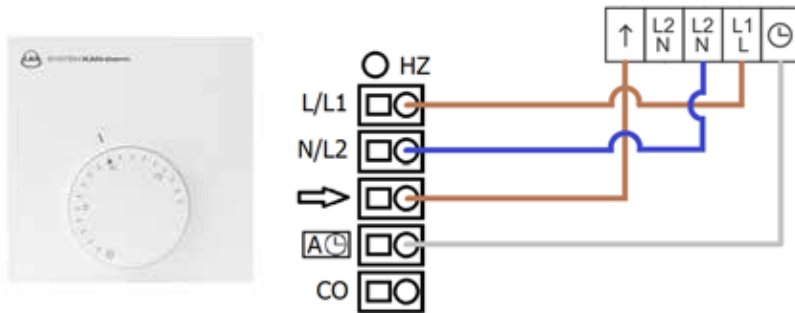

Fig. 60. Diagram of wiring of temperature sensor to the Basic+ 230 V or 24 V terminal block (with the option of periodic temperature reduction by connecting an external clock)

Electronic temperature sensor with hidden pre-set Basic+ is used to control electric servomotors in KAN-therm radiant heating and allows to maintain the set temperature in the room. Temperature setting is performed after removing the housing, and after its re-installation, temperature changes are impossible, in particular, for third parties. It is available in a 24 V or 230 V version.

## Basic+ 230 V or 24 V room thermostat



**Fig. 61.** Diagram of wiring of room thermostat for heating to the Basic+ 230 V or 24 V terminal block (with the option of periodic temperature reduction by connecting an external clock)

Basic+ electronic room thermostat is responsible for controlling executive elements – electric servomotors in KAN-therm surface heating and allows for individual adjustment of temperature in a room. The thermostat can be mounted directly on a wall. It is available in 24 V and 230 V versions.

### Thermostat features:

- adjustment of temperature setting – from -2 °C up to +2 °C,
- lowering of temperature by 4 °C, controlled by an external clock,
- temperature setting range limiter,
- protection against electronic system overload.



„User manual analogue thermostat Basic+ 230 V – 24 V”

## Basic+ 230 V or 24 V heating/cooling room thermostat

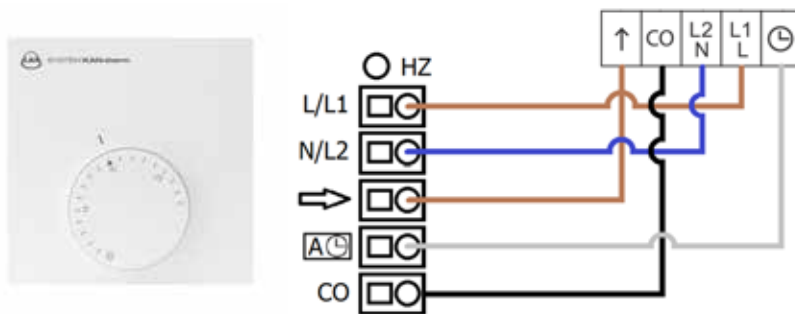

**Fig. 62.** Diagram of wiring of room thermostat for heating and cooling to the Basic+ 230 V or 24 V terminal block (with the option of periodic temperature reduction by connecting an external clock)

Basic+ heating/cooling electronic room thermostat is responsible for controlling executive elements – electric servomotors in KAN-therm surface heating and cooling and allows for individual adjustment of temperature in a room. The thermostat can be mounted directly on a wall. It is available in 24 V and 230 V versions.

### Thermostat features:

- adjustment of temperature setting – from -2 °C up to +2 °C,
- lowering of temperature by 4 °C, controlled by an external clock,
- temperature setting range limiter,
- protection against electronic system overload.



„User manual analogue thermostat Basic+ 230 V – 24 V”

## Weekly regulator with 230 V floor sensor

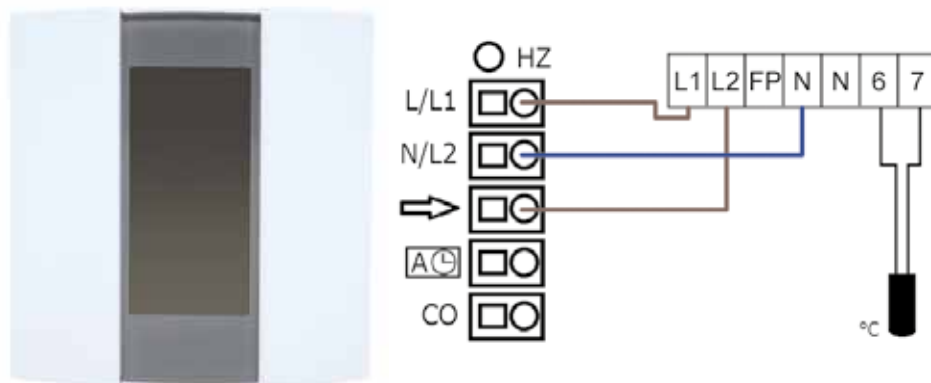

**Fig. 63.** Diagram of wiring of weekly regulator for heating to the Basic+ 230 V terminal block (with the option of floor temperature sensor).

1. floor temperature sensor (limiter).

This thermostat allows for individual adjustment of a room temperature with a function of weekly programming.

It is equipped with a floor temperature sensor. Operates in 3 adjustment modes:

- A** – air temperature in a room,
- F** – floor temperature,
- AF** – air and floor temperature.

It can cooperate with Basic+ electrical terminal blocks version 230 V. Device may be mounted inside flush-mounted box only.



„User manual weekly regulator with 230 V floor sensor“

### Basic+ with LCD Standard 230 V or 24 V electronic thermostat

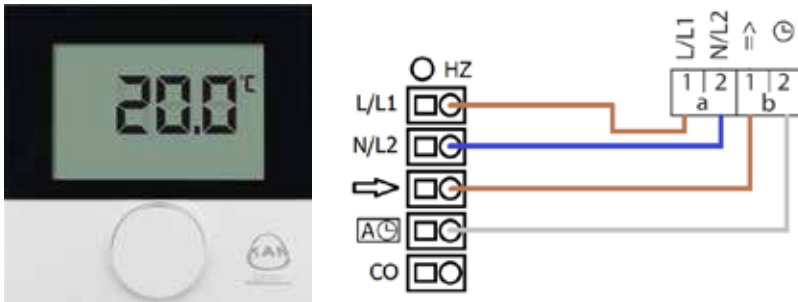

**Fig. 64.** Diagram of wiring of room thermostat for heating to the Basic+ 230 V or 24 V terminal block (with the option of periodic temperature reduction by connecting an external clock).

Electronic room thermostat is responsible for controlling executive elements – electric actuators in KAN-therm surface heating and allows for individual adjustment of temperature in a room. The thermostat can be mounted directly on a wall. It is available in 24 V and 230 V versions.



**Caution: Thermostat is not equipped with timer or display backlight.**

### Basic+ with LCD Control heating/cooling, 230 V or 24 V electronic thermostat

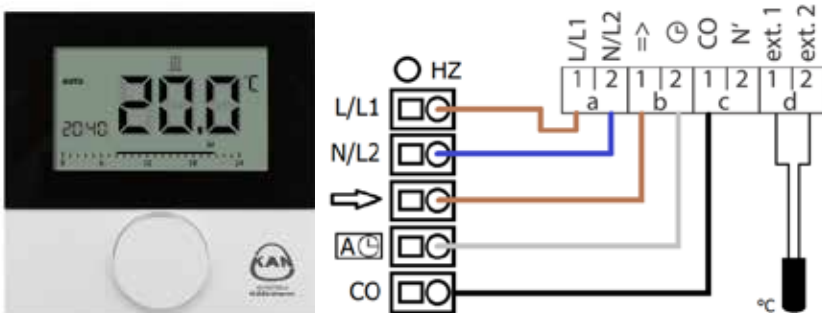







**Fig. 65.** Diagram of wiring of room thermostat for heating and cooling to the Basic+ 230 V or 24 V terminal block (with the option of periodic temperature reduction by utilizing it's internal timer for other room thermostats).

Floor temperature sensor is optional (not included in set).

This thermostat allows for individual adjustment of a room temperature with a function of weekly programming. It may be equipped with a floor temperature sensor. Thermostat has a manual and automatic adjustment option, weekly programming and Lifestyle options. As an only version may be used with normally closed (NC) and normally open (NO) servomotors.

The list of basic technical parameters and 230 V or 24 V thermostats functions

Tab. 1. 24 V/230 V KAN-therm thermostats and cable regulators

Type/model	Features and functions						Cooperation
	Max number of actuators	Cooling	Programming	Adjustment range °C	Temperature reduction	Rate setting adjustment	Electric terminal blocks
<b>Bimetallic room thermostat 24 V/230 V</b> 	10	—	—	5–30			LE Basic+ 24 V/230 V
<b>Temperature sensor with hidden pre-set Basic+</b> 	10	—	—	10–28	4 °C	—	Basic+ with 24 V/230 V pump module
<b>Room thermostat 24 V/230 V, electronic Basic+</b> 	10	—	—	10–28	4 °C	±2 °C	Basic+ with 24 V/230 V pump module
<b>Room thermostat 24 V/230 V (heating/cooling), electronic Basic+</b> 	10/3W	yes	—	10–28	4 °C	±2 °C	Basic+ 24 V/230 V heating/cooling
<b>Room thermostat 24 V/230 V (heating/cooling with LCD Control)</b> 	5	yes	7-day with 4 changes daily	5–30	2 °C	±0,2 °C	Basic+ 24 V/230 V heating/cooling
<b>Room thermostat Basic+ with LCD Standard</b> 	5	—	—	5–30	2 °C	±0,2 °C	Basic+ with 24 V/230 V pump module
<b>Week thermostat 230 V with a floor sensor</b> 	15	—	7-day with 4 changes daily	air: 5–30 floor: 5–40	-	-	Basic+ 230 V

## Installation guidelines for KAN-therm thermostats

Guidelines concerning the installation of thermostats are presented on the pictures.

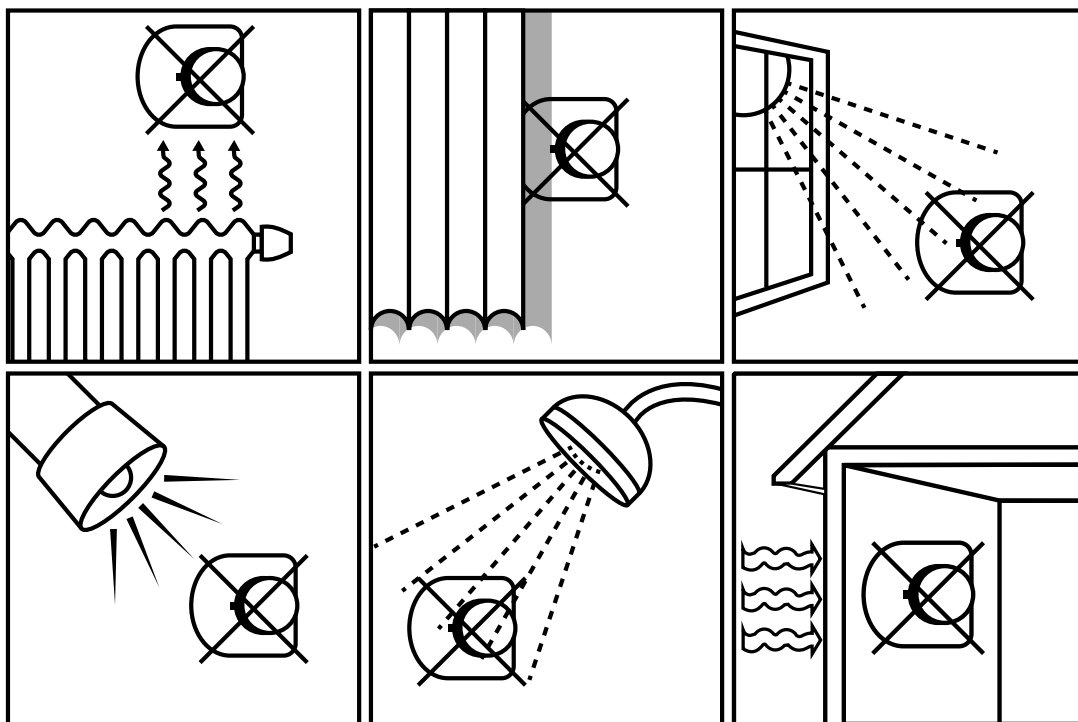
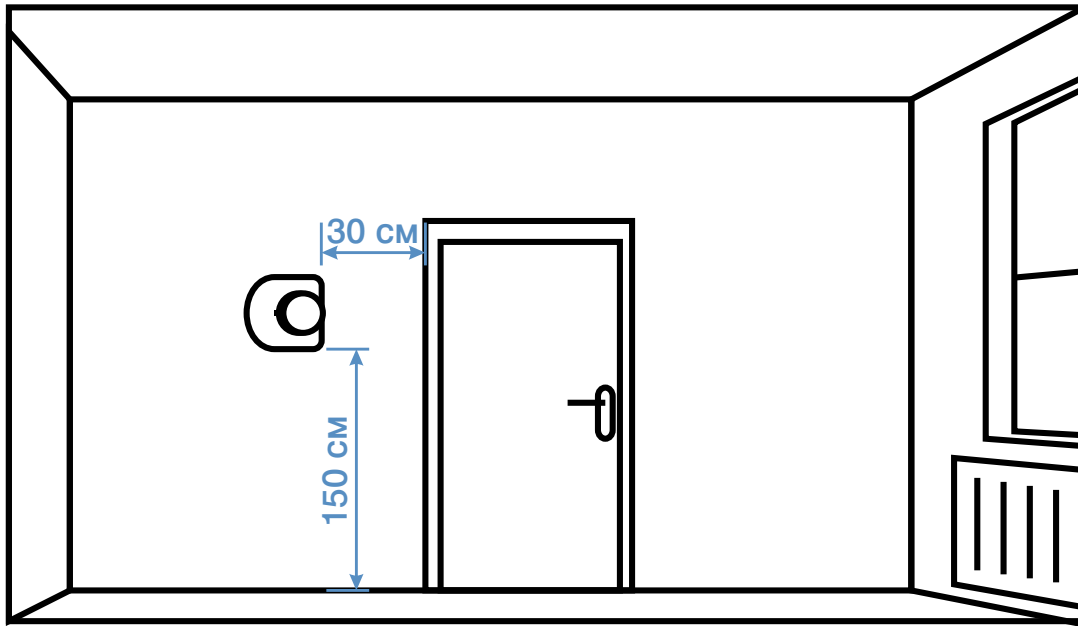

Thermostats mounting should be performed in accordance with the manuals, attached to the product.



**All manuals are available for download at [en.kan-therm.com](http://en.kan-therm.com)**

The number of electric cables cores and their cross-sections should be accordant with the information included in the manual of each product.

All works related to electrical installations must be carried out by a qualified personnel.

## KAN-therm wired electrical terminal blocks

KAN-therm connection electrical terminal blocks allow for a quick and convenient connection of servomotors, thermostats, control clocks and power supply connection (230 V or 24 V) in a single place (e.g. installation cabinet above the manifold). Some terminal block models have a pump module, which controls the mixing system pump operation. All terminal blocks versions cooperate with reliable KAN-therm Smart thermoelectric servomotors, adapted to the voltage of 230 V or 24 V.

### Basic+ 230 V or 24 V electrical terminal block

The version with a built-in pump module allows the connection of up to 6 thermostats and 12 servomotors or 10 thermostats and 18 servomotors (depending on the version). The terminal block carries out heating and cooling function.



Fig. 66. Electrical terminal block Basic+ 230 V or 24 V. 24 V version needs additional 230 – 24 AC to AC power converter.

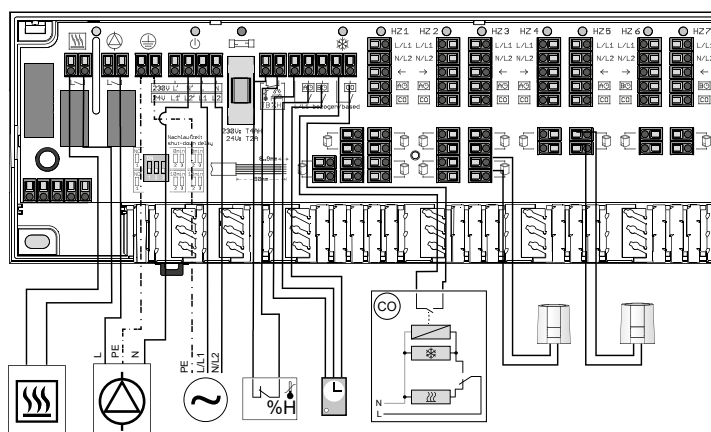

Fig. 67. Technical diagram of Basic+ 230 V or 24 V terminal block with pump module, boiler module and peripheral devices.



Installation and configuration of the terminal block is shown in the manual „Electrical terminal block for heating/cooling with the Basic+ 230 V/24 V pump module“

## The list of basic technical parameters and functions of 230 V, 24 V wired electrical terminal blocks

**Basic+ terminal blocks** provides power to all control elements. They are available in the heating – cooling version with the possibility of controlling 6 or 10 heating zones. Both sizes of terminal blocks are available in 230 V and 24 V versions (230 V/24 V AC – AC transformer required). They may control the operation of the boiler and the circulation pump. Additionally, the automation system can be overridden to work with devices (pump, boiler) normally closed (NC) and normally open (NO).

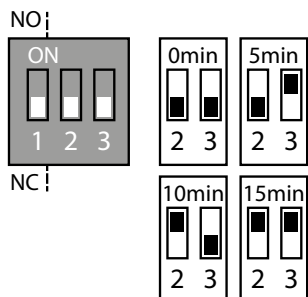

The mode of operation is set by Jumper 1:

**Mode NO:** Jumper 1 = ON

**Mode NC:** Jumper 1 = OFF

The fixed pump or boiler run-on time of 2 minutes can be increased by a further 5, 10 or 15 minutes using Jumper 2 and 3:

**Note:** Jumper 1 is responsible for overriding the pump module and the boiler – it does not affect the operation mode of the electric servomotors.

Additional run-on time	Jumper 2	Jumper 3
0 min	OFF	OFF
5 min	OFF	ON
10 min	ON	OFF
15 min	ON	ON

Basic+ Terminal block	24 V	230 V
Protective wire clamp		+
Pump / boiler electrical feed (230 V)		+
Dew point sensor power terminals (24 V)	+	
Configurable delay of pump module / boiler module shut-down	+	+
Direct action pump module		+
Connection for temperature limiter or dew sensor	+	+
External timer connection	+	+
Changeover between heating and cooling (CO)	+	+
Control of the servomotors normally closed (NC) and normally open (NO)	change from a thermostat	change from a thermostat
LED status signaling	+	+
Number of supported heating zones	6 or 10	6 or 10

Terminal blocks mounting should be performed in accordance with the manuals, attached to the product.



**All manuals are available for download at [en.kan-therm.com](http://en.kan-therm.com)**

The way of preparing the electric cables terminals, their mounting in electric clamps, as well as cables cross-sections should be accordant with the information included in the manual of each product.

All works related to electrical installation must be carried out by a qualified personnel.

## KAN-therm Smart 230 V or 24 V electric servomotors



KAN-therm Smart are modern thermoelectric drives, responsible for opening and closing of surface heating and cooling system valves. They cooperate, through electrical terminal blocks, with thermostats regulating the temperature in rooms. They are mounted on cut-off valves (thermostatic) in KAN-therm system underfloor heating manifolds. The servomotor can also be mounted on thermostatic valve, located on pump mixing unit supply. Then it acts as a valve executive element (through regulator – thermostat), which controls all circuits connected to the manifold – a system applied, when all heating circuits are located in the same, single room.

- 230 V or 24 V versions,
- „First Open” function, which makes the servomotor mounting and execution of pressure test easier,
- Possibility to select an servomotor operating in NC or NO mode,
- Quick assembly using KAN-therm M28 × 1,5 or M30 × 1,5 adapters,
- Secure fastening with three-point locking system,
- Servomotor calibration – automatic adjustment to the valve,
- Visualization of servomotor operation status,
- Actuator assembly in any position,
- 100% secured against water and humidity,
- Energy efficient – only 1W energy consumption.

Servomotors are mounted on valves through KAN-therm M28 × 1,5 or M30 × 1,5 plastic adapters (depending on the valve's thread size).

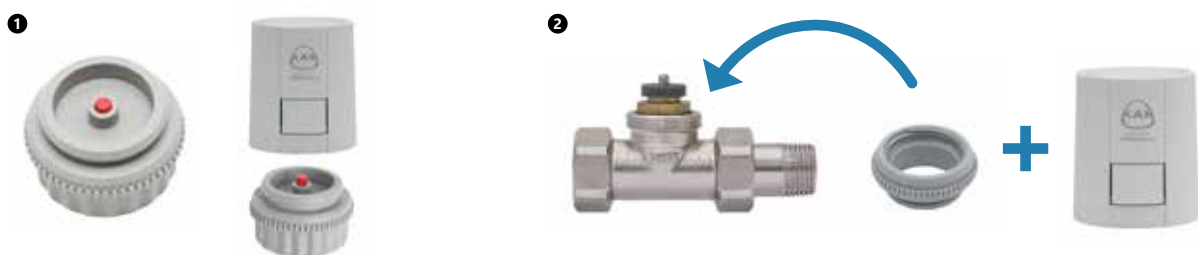

1. M28 × 1,5 adapter for servomotors – used for KAN-therm brass manifolds.

2. M30 × 1,5 adapter for servomotors – used for KAN-therm stainless steel manifolds and thermostatic valves on mixing unit inlet.



## Note

KAN-therm Smart servomotors are fully compatible with previously used KAN-therm servomotors in terms of mounting method.

### KAN-therm Smart servomotors technical parameters

Version	De-energised closed (NC)		De-energised open (NO)	
Voltage	230 V AC 50/60 Hz	24 V AC/DC 60 Hz	230 V AC 50/60 Hz	24 V AC/DC 60 Hz
Drive power	1,0 W			
Max. activation current	< 550 mA for max 100 ms	< 300 mA for max 2 min	< 550 mA for max 100 ms	< 300 mA for max 2 min
Positioning force	100 N ± 5%			
Closing and opening time	approximately 6 min			
Setting route (indicator jump)	4 mm			
Storage temperature	from -25 to 60°C			
Ambient temperature	from 0 to +60°C			
Protection degree / class	IP 54			
Connection cable / cable length	2 × 0,75 mm <sup>2</sup> / 1 m			

The mounting and exploitation of servomotors should be performed in accordance with KAN-therm manuals.



## Note!

KAN-therm servomotor in NC version is delivered partially opened (the function of first opening – “First Open”). It allows the execution of installation leakage test and heating of a building in raw unfinished condition, even when the electrical wiring of individual rooms is not ready. During later activation, by applying operating voltage (for longer than 6 minutes), the function of the first opening unlocks automatically and the drive is fully operational. After initial activation the KAN-therm NC servomotors in de-energised condition are closed.

KAN-therm Smart type NC servomotors cooperate with all KAN-therm wired terminal blocks and room thermostats.

## Other elements of control and automatics

### Icing controller for open surfaces icing with a snow and ice sensor



The regulator operating in cooperation with the heating system in automatic mode protects against icing and accumulation of snow on external traffic routes (stairs, sidewalks, driveways).

The heating system turns on only when there is a risk of snowfall, freezing rain or ice. After they melt, it turns off automatically. Thus, contrary to only thermostat-controlled systems, it is possible to save up to 80% of energy.

Regulator standard settings allow for heating system operation in temperature and humidity values controlling mode. Heating is enabled, if the temperature drops below 3 °C, and humidity exceeds level 3 (in 0–8 scale). The regulator determines an optimal time for a switch off, in order to prevent the formation of ice early enough. If the surface temperature falls below the set in menu basic value of -5 °C, heating enables regardless of humidity level and remains enabled, until the temperature rises above -5 °C. If the additional heating function is activated, heating shall remain enabled, until the set time elapses.

Snow and ice sensor is equipped with a 15 meters long cable (may be extended to 50 m).



**“The regulator of open surfaces heating with snow and ice sensor” manual.**

### Surface heating unit with vent and thermostatic valve



The device controlling temperature in a room regulates the flow of medium through single floor heating circuit, without additional heaters, depending on ambient temperature. Room set can be mounted both on the supply and return in floor heating circuit. Thermostat receives the ambient temperature and properly regulates the flow of water in a heating circuit.

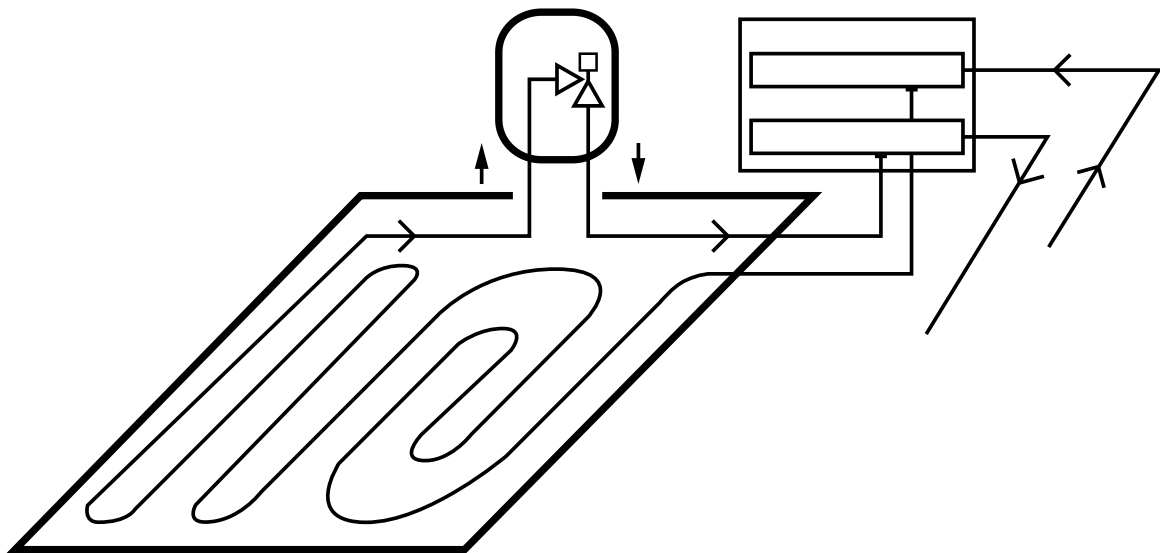

Fig. 68. Operation scheme – unit located at the return



### “Surface heating unit with vent and thermostatic valve” manual

### Return temperature limiter and room controller Premium RTL Kombi UP DUO



Set with adjustable return temperature limitation intended for surface heating installation regulation depending on ambient temperature. Device is equipped with two thermostatic heads – external for setting the room temperature and internal for return temperature limitation. Set is useful in both renovated as well as new buildings in installations assembled later in combination with direct heating circuit without mixing unit. Set is placed on return of surface heating circuit.

## 7 Designing **KAN-therm** surface heaters

### 7.1 Dimensioning of heating systems – assumptions

Designing of floor (and wall) heaters in the KAN-therm system is based on the methodology defined in EN 1264: "Water based surface embedded heating and cooling systems". It adopts the following assumptions:

- the basis for calculating the density of heat flux emitted into the room is the log mean temperature difference between the temperature of the heating medium and the air temperature in the room,
- no additional heat sources are embedded in the floor,
- lateral heat transfer is ignored,
- floor heating without the finish layer emits downwards 10% of the heat flux emitted upwards.

According to EN 1264 the heat flux density  $q$  transferred by a surface heater is given by the formula:

$$q = K_H \cdot \Delta\vartheta_H \text{ [W/m}^2\text{]}$$

where:

$\Delta\vartheta_H$  – is the logarithmic temperature difference [K],

$K_H$  – constant composed of the following factors resulting from the design of the floor heater:

- composite factor dependent on the type of floor heating and the design of pipe,
- factor dependent on the type of finish layer,
- factor dependent on the spacing of pipes,
- factor dependent of the screed thickness over the pipes,
- factor dependent on the inner diameter of pipes.

The log mean temperature difference  $\Delta\vartheta_H$  is calculated based on:

$$\Delta\vartheta_H = \frac{\vartheta_z - \vartheta_p}{\ln \left[ \frac{\vartheta_z - \vartheta_i}{\vartheta_p - \vartheta_i} \right]}$$

where:

$\vartheta_z$  – is the supply temperature of floor heating [°C],

$\vartheta_p$  – heating medium return temperature [°C],

$\vartheta_i$  – air temperature in the room [°C].

In order to facilitate calculations the above relationship is presented in tables (developed for various temperatures of heating medium and air).

Based on the  $\Delta\vartheta_H$  values provided in the table as well as the parameters of the surface heating design (screed thickness over the pipe, diameter and spacing of pipes, type of floor covering) it is possible to determine the value of the heat flux emitted to the space within the scope of the project.

Tab. 1.  $K_H$  coefficient values for Tacker, Profil, Rail and NET system, depending on pipe diameter  $\phi$ , pipe spacing T and pipe thickness  $s_u$  as well as floor finish  $R_{\lambda B}$

$\phi$	$K_H$																
	0,00			0,05			0,10			0,15							
	$R_{\lambda B}$	$s_u$	T	$R_{\lambda B}$	$s_u$	T	$R_{\lambda B}$	$s_u$	T	$R_{\lambda B}$	$s_u$	T					
<b>12x2,0</b>	0,10	8,03	7,10	6,29	5,56	5,67	5,14	4,66	4,23	4,35	4,03	3,73	3,46	3,52	3,30	3,09	2,89
	0,15	7,10	6,35	5,69	5,09	5,13	4,68	4,28	3,91	3,99	3,72	3,48	3,24	3,27	3,08	2,90	2,73
	0,20	6,20	5,62	5,08	4,60	4,59	4,24	3,91	3,61	3,65	3,43	3,22	3,03	3,03	2,87	2,72	2,58
	0,25	5,39	4,94	4,52	4,14	4,10	3,82	3,56	3,31	3,33	3,15	2,98	2,81	2,80	2,67	2,55	2,43
	0,30	4,68	4,33	4,01	3,71	3,66	3,44	3,24	3,05	3,03	2,89	2,75	2,63	2,59	2,48	2,38	2,29
	0,10	8,14	7,21	6,38	5,64	5,74	5,20	4,72	4,28	4,40	4,08	3,77	3,50	3,56	3,33	3,12	2,92
<b>14x2,0</b>	0,15	7,24	6,48	5,80	5,19	5,21	4,76	4,35	3,98	4,05	3,78	3,53	3,29	3,31	3,12	2,93	2,76
	0,20	6,34	5,74	5,20	4,71	4,68	4,32	3,99	3,68	3,71	3,49	3,28	3,08	3,08	2,92	2,76	2,62
	0,25	5,53	5,06	4,63	4,24	4,19	3,90	3,64	3,39	3,39	3,21	3,03	2,87	2,85	2,72	2,59	2,47
	0,30	4,80	4,45	4,11	3,81	3,75	3,52	3,32	3,12	3,09	2,95	2,81	2,68	2,64	2,53	2,43	2,33
	0,10	8,26	7,31	6,47	5,72	5,81	5,27	4,78	4,34	4,45	4,12	3,82	3,54	3,59	3,36	3,15	2,94
	0,15	7,38	6,61	5,92	5,29	5,30	4,84	4,43	4,05	4,10	3,83	3,58	3,34	3,35	3,15	2,97	2,80
<b>16x2,0</b>	0,20	6,49	5,81	5,32	4,81	4,78	4,41	4,07	3,75	3,78	3,55	3,34	3,14	3,12	2,96	2,80	2,66
	0,25	5,66	5,19	4,75	4,35	4,28	3,99	3,72	3,46	3,46	3,27	3,09	2,92	2,90	2,76	2,63	2,51
	0,30	4,93	4,56	4,22	3,91	3,84	3,61	3,40	3,19	3,16	3,02	2,88	2,74	2,69	2,58	2,48	2,37
	0,10	8,38	7,41	6,56	5,81	5,88	5,33	4,84	4,39	4,50	4,16	3,86	3,57	3,62	3,39	3,17	2,97
	0,15	7,53	6,74	6,03	5,40	5,39	4,93	4,50	4,11	4,16	3,89	3,63	3,39	3,39	3,19	3,01	2,83
	0,20	6,64	6,01	5,44	4,92	4,87	4,49	4,15	3,83	3,84	3,61	3,39	3,19	3,17	3,00	2,85	2,70
<b>18x2,0</b>	0,25	5,80	5,31	4,87	4,46	4,37	4,08	3,80	3,54	3,53	3,34	3,15	2,98	2,95	2,81	2,68	2,55
	0,30	5,06	4,68	4,33	4,01	3,93	3,70	3,48	3,27	3,23	3,08	2,94	2,80	2,74	2,63	2,52	2,42
	0,10	8,50	7,52	6,66	5,89	5,95	5,40	4,90	4,44	4,55	4,21	3,90	3,61	3,65	3,42	3,20	3,00
	0,15	7,68	6,87	6,15	5,51	5,48	5,01	4,58	4,18	4,22	3,94	3,68	3,43	3,43	3,23	3,04	2,86
	0,20	6,79	6,14	5,56	5,04	4,97	4,58	4,23	3,90	3,91	3,67	3,45	3,24	3,22	3,05	2,89	2,74
	0,25	5,95	5,44	4,99	4,57	4,47	4,17	3,88	3,62	3,60	3,40	3,21	3,04	3,00	2,86	2,72	2,60
0,30	5,19	4,80	4,45	4,11	4,02	3,79	3,56	3,35	3,30	3,15	3,00	2,86	2,79	2,68	2,57	2,47	

Tab. 2.  $K_H$  coefficient values for TBS system, depending on pipe diameter  $\phi$ , pipe spacing T and pipe thickness  $s_u$  as well as floor finish  $R_{\lambda B}$

$\phi$	$K_H$																
	0,00			0,05			0,10			0,15							
	$R_{\lambda B}$	$s_u$	T	$R_{\lambda B}$	$s_u$	T	$R_{\lambda B}$	$s_u$	T	$R_{\lambda B}$	$s_u$	T					
<b>16x2,0</b>	0,166	6,04	5,81	5,72	5,23	4,45	4,33	4,28	4,00	3,53	3,45	3,42	3,23	2,92	2,87	2,84	2,72
	0,250	4,44	4,28	4,22	3,99	3,50	3,39	3,35	3,21	2,88	2,81	2,78	2,68	2,45	2,40	2,38	2,30
	0,333	3,15	3,03	2,99	2,64	2,63	2,55	2,52	2,26	2,26	2,20	2,17	1,98	1,98	1,93	1,91	1,76

$R_{\lambda B} = 0,00$  [m<sup>2</sup>K/W)–ceramic tiling, thickness up to 12 mm and stone tiling, thickness up to 25 mm

$R_{\lambda B} = 0,05$  [m<sup>2</sup>K/W)–floor covering of plastic and resins up to 6 mm

$R_{\lambda B} = 0,10$  [m<sup>2</sup>K/W)–floor panels, thickness up to 10 mm and carpets, thickness up to 6 mm

$R_{\lambda B} = 0,15$  [m<sup>2</sup>K/W)–wooden panels and wood flooring, thickness up to 15 mm and carpets, thickness up to 10 mm

**Tab. 3. Values of the log mean temperature difference  $\Delta\vartheta_H$  depending on the feed temperature  $\vartheta_V$  and return temperature  $\vartheta_R$  of the medium and indoor air temperature  $\vartheta_i$**

$\vartheta_V$	$\vartheta_R$	$\vartheta_i$								
		[°C]								
[°C]	[°C]	5	8	10	12	16	18	20	22	24
30	25	22,4	19,4	17,4	15,4	11,3	9,3	7,2	5,1	2,8
	20	19,6	16,5	14,4	12,3	8,0	5,6			
	15	16,4	13,1	10,8	8,4					
35	30	27,4	24,4	22,4	20,4	16,4	14,4	12,3	10,3	8,2
	25	24,7	21,6	19,6	17,5	13,4	11,3	9,1	6,8	4,2
	20	21,6	18,5	16,4	14,2	9,6	7,0			
40	35	32,4	29,4	27,4	25,4	21,4	19,4	17,4	15,4	13,3
	30	29,7	26,7	24,7	22,6	18,6	16,5	14,4	12,3	10,2
	25	26,8	23,7	21,6	19,6	15,3	13,1	10,8	8,4	5,4
45	40	37,4	34,4	32,4	30,4	26,4	24,4	22,4	20,4	18,4
	35	34,8	31,7	29,7	27,7	23,6	21,6	19,6	17,5	15,5
	30	31,9	28,9	26,8	24,7	20,6	18,5	16,4	14,2	12,0
50	45	42,5	39,4	37,4	35,4	31,4	29,4	27,4	25,4	23,4
	40	39,8	36,8	34,8	32,7	28,7	26,7	24,7	22,6	20,6
	35	37,0	33,9	31,9	29,9	25,8	23,7	21,6	19,6	17,4
55	50	47,5	44,5	42,5	40,4	36,4	34,4	32,4	30,4	28,4
	45	44,8	41,8	39,8	37,8	33,8	31,7	29,7	27,7	25,7
	40	42,1	39,0	37,0	35,0	30,9	28,9	26,8	24,7	22,7

## Maximum temperature of surface

In terms of human thermal comfort, the most favourable temperature of the surface is app. 26 °C. Since the heat output of a surface heating may often be insufficient at this temperature, it is assumed (in accordance with EN 1264) that the maximum temperature may reach the following values:

### floor heating:

- 29 °C for human occupied zones (air temperature  $\vartheta_i=20$  °C),
- 33 °C for bathrooms ( $\vartheta_i=24$  °C),
- 35 °C for edge zones (most vulnerable to heat loss) ( $\vartheta_i=20$  °C).

### wall heating:

- 40 °C ( $\vartheta_i=20$  °C).

### ceiling heating:

- 35 °C ( $\vartheta_i=20$  °C).

Maintaining these maximum temperatures reduces the thermal efficiency of floors (heat flux density) to the limiting values of  $q_{max}$  100 W/m<sup>2</sup> for human occupied zones and bathrooms and of 175 W/m<sup>2</sup> for edge zones (assuming the design temperatures of these zones is maintained).

Respectively, the  $q_{max}$  will be 160 W/m<sup>2</sup> in the case of walls and 98 W/m<sup>2</sup> for ceilings.

If the heat loss is higher than the values resulting from the maximum performance of surface heating, additional heat sources or zones featuring higher thermal efficiency should be provided (edge zones with narrower pipe spacing).

In contrast, in the case of surface cooling, the minimum surface temperature should be individually determined depending on the assumed climatic conditions in order to protect the surface against water vapor condensation. For this purpose, the Mollier chart should be used.

For example, if the air temperature inside the room is 26 °C and the relative humidity is 60%, then it is easy to read from the Mollier diagram that the temperature of the cooling surface cannot be lower than 18 °C (lower temperature will cause water vapor to condense).

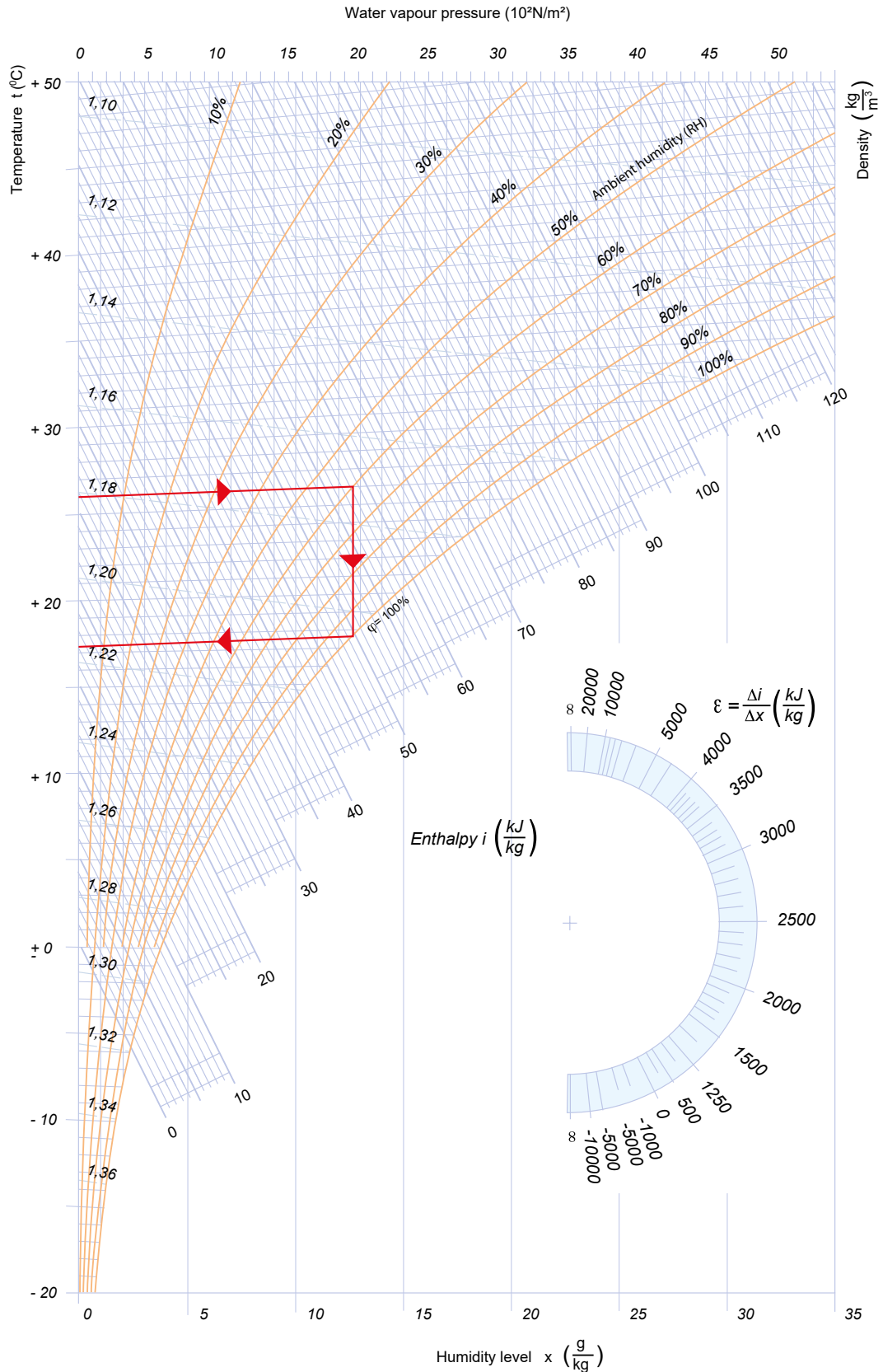

The determination of maximum achievable unit heat output depending on the installation type, its localization in the building structure and temperature difference between ambient room temperature and heating partition (or cooling) the following formula can be utilized:

$$q_{\max} = \alpha \times \Delta T \text{ [W/m}^2\text{]}$$

where:

$q_{\max}$  - unit heat output [W/m<sup>2</sup>]

$\alpha$  - heat transfer coefficient from the partition [W/m<sup>2</sup>K]

$\Delta T$  - module (absolute value) of the temperature difference between the ambient room and the heating/cooling partition temperature

The alpha heat transfer coefficients are presented in the graphic below:



### Thermal and hydraulic dimensioning of the surface wall heaters

The general rules for designing KAN-therm wall heating/cooling systems do not differ from the rules of dimensioning of surface heating and cooling systems given in the Part 7 of the Guidebook - Designing KAN-therm surface heaters.

**In addition, the following criteria should be taken into account:**

- maximum wall surface temperature (heating) 40 °C,
- minimum wall surface temperature (cooling) 19 °C, as long as it does not cause moisture condensation,
- maximum installation supply temperature 50 °C,
- water temperature drop in pipes from 5 to 10 K (for pipes with diameters 12 × 2 mm, 14 × 2 mm, 16 × 2 mm), and from 2,5 to 7,5 K, average (recommended) 5 K (for pipes with diameter 8 × 1 mm),
- pipe spacing, depending on diameter, laid in series pattern,
- minimum water velocity for effective deaeration of the system 0,15 m/s,

- approximate maximum permissible water velocity 0,8 m/s (for 8 × 1 pipes - 0,3 m/s),
- approximate maximum lengths of heating loops: 80 m for 14 × 2 mm pipes and 60 m for 12 × 2 mm pipes, 40 m for 8 × 1 mm pipes (including connection sections),
- when using 8 × 1 mm pipes, it is recommended to use the following connection and laying options for the wall installation:

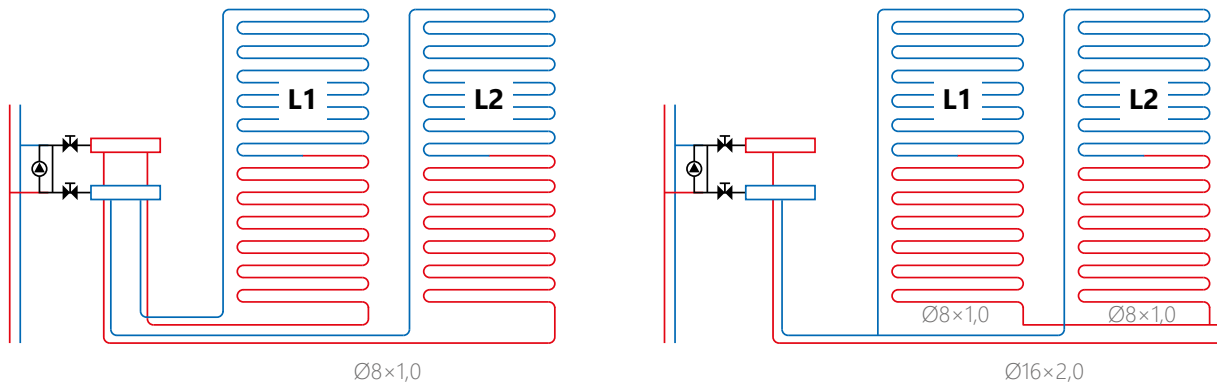

- at internal walls, the thermal resistance of all wall layers up to pipe surface should not be lower than  $0,75 \text{ m}^2 \times \text{K/W}$  (unless we consider heating adjacent rooms).

For the determination of the thermal output of wall heaters depending on the diameter  $D$ , the pipe spacing  $T$  (10, 15, 20 and 25 cm), the thickness  $S_u$ , the thermal properties of the plaster and the average temperature  $\Delta V_H = \left( \frac{t_v + t_R}{2} \right) - t_i$ , there are tables available for a plaster with 20 mm thickness (above the pipe surface) and for a conductivity coefficient  $\lambda = 0,8 \text{ W/m} \times \text{K}$  and for values of specific conductivity resistance of the wall finishing layer  $R\lambda = 0,00; 0,05; 0,10; 0,15 \text{ m}^2 \times \text{K/W}$ .

## Edge zones

In order to increase the heat output and to obtain more even temperature distribution a room with "cold" partitions (such as glazed exterior walls) may feature zones, 1 m wide, along such partitions, of narrower pipe spacing – the edge zones. Floor surface temperature in such zone will be higher but should not exceed 35 °C.

The coil of such zone can be integrated with heating pipes arranged in zone permanently occupied by humans but it must be supplied first and heat fluxes for both zones must be calculated separately. For higher heat losses it is preferable to add a zone with a dedicated circuit. Drawings of edge zones on **Fig. 10, Fig. 11, Fig. 12** of the chapter "Underfloor heating and cooling in KAN-therm system".

For spaces with edge zones, in order to determine the thermal power for zones permanently occupied by humans, the thermal power generated by the edge zone must be deducted from the total heat requirement  $Q_B = q_R \times A_R \text{ [W]}$ ,

where:

$q_R$  – heat flux of the edge zone resulting from narrower pipe spacing  $[\text{W/m}^2]$

$A_R$  – edge zone surface area  $[\text{m}^2]$

The intended use of edge zones should not be modified during operation to, for example, zones permanently occupied by humans by rearranging the interior. Edge zone should not be covered with wooden linings.

## Supply temperatures for surface installations

Hydronic surface installations are low-temperature systems.

In the case of heating installations in line with EN 1264, the maximum temperature of heating water supply is 60 °C (for design external temperature) and the optimum temperature drop of water in the loops is at the level of 10 °C (permissible range 5÷15 °C).

In surface cooling installations in line with EN 1264, on the other hand, the minimum temperature of cooling water supply is the temperature resulting from the calculation of the water temperature increase at the level of 5 °C (permissible range 5÷10 °C) and the acceptable temperature of the cooling surface which can not be lower by more than 6 °C against the ambient room temperature (protection against condensation).

Typical parameters of supply and loop return water are, therefore:

### surface heating installations:

- 55 °C/45 °C
- 50 °C/40 °C
- 45 °C/35 °C
- 40 °C/30 °C

### surface cooling installations:

- 22 °C/17 °C
- 20 °C/15 °C
- 17 °C/12 °C

Supply and return temperature for the entire system is determined for the room with the highest specific heat/cold demand.

## 7.2 Hydraulic calculations for the installation, adjustments

The flux of water mass  $m_H$  flowing through the heating circuit can be calculated, with sufficient accuracy (assuming minimum thermal insulation resistance underneath the heating pipes) using the following formula:

$$m_H = (A_F \times q) / (\sigma \times C_w) \text{ [kg/s]}$$

where:

$A_F$  – surface area of the surface heating [m<sup>2</sup>]

$q$  – heat flux transferred by the surface heating to the heated space [W/m<sup>2</sup>]

$\sigma$  – temperature drop of the heating medium [K]

$c_w$  – water specific heat coefficient = 4190 J/(kg × K)

Total pressure drop in the circuit  $\Delta p$  (selection of the pump should be based on the least performing circuit) involves linear resistance over the length of the coil  $\Delta p_L$  and the combination of local resistance at manifold valves –  $\Delta p_V$  and  $\Delta p_R$ .

$$\Delta p = \Delta p_L + \Delta p_V + \Delta p_R \text{ [Pa]}$$

Linear pressure drop  $\Delta p_L$  can be determined using tables of specific linear pressure drop of KAN-therm pipes, assuming minimum flow rate at  $v_{min} = 0,15$  m/s.

The overall length of the heating circuit is made up of the heating field pipes' length plus the length of the supply and return pipes (transit pipes - from the manifold to the heating field). The approximate length of the coil can be determined from the following relationship:

$$L = A_F / T \text{ [m]}$$

where T is the spacing of the loop pipes [m].

Unit [m/m<sup>2</sup>] pipe consumption is also provided in the tables, see the chapter on individual fastening systems for KAN-therm pipes.

The values of local pressure drop on the manifold can be determined based on the properties of valves embedded in KAN-therm manifolds.

Total pressure drop in the circuit should not exceed 20 kPa.

The approximate maximum length of circuits (including feed and return pipes) of KAN-therm pipes:

- 12 × 2 – 60 m
- 14 × 2 – 80 m
- 16 × 2 – 100 m
- 18 × 2 – 120 m
- 20 × 2 – 160 m
- 25 × 2,5 – 180 m

Once the pressure losses have been determined for the circuit with biggest pressure drop, adjust the remaining circuits of the manifold by determining relevant set values measured by the number of turns of the valve head, based on parameters of control valves (for adjustment procedure see Instructions for KAN-therm manifolds).

Manifolds with flow meters are adjusted by setting the flow rate for each flow meter, calculated for its corresponding circuit.

### 7.3 Computer aided design KAN software packages

Principles of KAN-therm surface heaters design are not different from generally applicable rules, based on current standards and guidelines for installation dimensioning. KAN proposes utilization of proprietary software supporting designing which significantly improves the calculations process. These software contains libraries of all KAN-therm systems currently available in the offer. Thus, designers receive universal tools that enable free dimensioning of installations in virtually every system used in installation technology.

The complete KAN software offer includes:

KAN OZC program for supporting the calculation of the design heat loads of rooms, determining the seasonal demand for heating and cooling energy in buildings and the preparation of Energy Certificates for buildings and their parts. The software also perform moisture analysis of building partitions.

The KAN SET software is a comprehensive design support tool that combines in one project the calculation of cold and hot water installations with circulation as well as central heating and cooling installations. It consists of three modules:

- Central heating system module, including radiant/underfloor heating,
- Cold and hot water installation module with circulation,
- Central cooling system module.

KAN SET for REVIT – plug-in for **Autodesk® Revit®**. It allows to import a design from KAN SET Pro to the **Autodesk® Revit®** environment. The plug-in enables easy and convenient design of installations using KAN-therm products.

Portal BIM - a collection of parametric BIM models dedicated to the Autodesk Revit environment and CAD libraries in the form of 3D models and 2D drawings.



**More information available at [www.kan-therm.com](http://www.kan-therm.com).**

## 8 Acceptance forms

In this section, we present acceptance forms templates:

- Installation pressure test protocol,
- Screed heating protocol,
- Hydraulic adjustment execution protocol.

### 8.1 Installation pressure test protocol



# PROTOCOL

Tightness test of  
KAN-therm systems  
Medium: compressed air

Investor:

Investment/address:

Contractor of the installation:

Storey/room:

Name of the system:

All pipes should be sealed with metal plugs, caps, inserts, plastic plugs or blind flanges. Appliances, pressure vessels and water heaters must be disconnected from the pipes. A visual inspection should be carried out to check that the installation has been carried out correctly. The air used for the test must be oil-free. In the case of the KAN-therm Steel system, the compressed air must also be free of moisture. The ambient temperature of the installation under test must remain constant (max. ±3 °C). Any leaks detected can be located acoustically or visually, using a foaming agent approved by KAN Technical Support Department. For a leak test at a pressure of 110 mbar (0.11 bar) for a pipe volume of 100 l, the test duration is at least 30 minutes. For every additional 100 l of system capacity, the test duration must be extended by 10 minutes. The pressure gauge must allow for effective verification of the pressure at 110 mbar. Subsequently, a load test must be carried out at an elevated pressure, not exceeding 3 bar (0.3 MPa).

Pipes capacity ..... L                      Duration time ..... min

**TIGHTNESS TEST**

Test pressure	Duration time:	Were leaks located during the visual inspection?	Did the test reveal pressure change?
110 mbar (0,11 bar)	30 minutes (up to a capacity of 100 litres; for every additional 100 litres, extend the test time by 10 minutes)	YES <input type="checkbox"/> NO <input type="checkbox"/>	YES <input type="checkbox"/> NO <input type="checkbox"/>

**LOAD TEST WITH INCREASED PRESSURE**

Test pressure	Duration time	Did the test reveal pressure drop?
≤DN50 maximum 3 bar <input type="checkbox"/>	10 min	YES <input type="checkbox"/> NO <input type="checkbox"/>
>DN50 maximum 1,5 bar <input type="checkbox"/>		

**SUMMARY:**

Date of test:                       Ambient temperature:

Test result:                      POSITIVE                       NEGATIVE

.....

Date of test

.....

Ordering party signature

.....

Contractor signature

[www.kan-therm.com](http://www.kan-therm.com)



# PROTOCOL

Tightness test of metal  
KAN-therm systems  
Medium: water

Investor:

Investment/address:

Contractor of the installation:

Storey/room:

Name of the system:

**Installation of hot and cold water and its circulation**

Test pressure  $P_{op} = P_{proj} \times 1,1$  [bar]

**Heating and cooling water installation**

Test pressure  $P_{op} = P_{work} + 2$  [bar] but not less than 4 bar

$P_{op}$  - pressure at which the tightness test is performed

$P_{proj}$  - maximum allowable pressure for the installation system

$P_{work}$  - system design pressure

Prior to the tightness test, diaphragm expansion vessels, fittings which may interfere with the test (e.g. differential pressure regulators, safety valves and any other installation components with an allowable working pressure lower than the test pressure must be disconnected).

The installation must be thoroughly flushed, filled with clean medium and vented before the test. The temperature of the medium should be stabilised in relation to the ambient temperature. For the test, use a manometer with a measuring range of 50% greater than the test pressure and an elementary scale of test pressure and an interval of 0.1 bar. Connect the manometer at the geometrically lowest point of the system.

The ambient temperature should not change during the test.

Perform The tightness test in 2 steps:

### PRELIMINARY TEST WITH REDUCED PRESSURE

Test pressure	Preliminary test conditions	Conditions of acceptance:
1.0 to 4.0 bar	- time to visually check all connections - keep the test pressure constant level	No moisture or leakage <input type="checkbox"/>

### MAIN TEST

Test pressure	Duration of the test	Conditions of acceptance:
$P_{op} = \text{-----}$	10 min	No moisture or leakage <input type="checkbox"/> No pressure drop <input type="checkbox"/>

### SUMMARY:

Ambient temperature:	Main test - duration	Pressure drop:
<input type="text"/>	<input type="text"/>	<input type="text"/>

Test result: **POSITIVE**  **NEGATIVE**

..... Date of test ..... Ordering party signature ..... Contractor signature .....

The procedure for carrying out a leak test on the system has been developed on the basis of standard EN 806-4 and own experience.

[www.kan-therm.com](http://www.kan-therm.com)



# PROTOCOL

Tightness test of plastic  
KAN-therm systems  
Medium: water

Investor:

Investment/address:

Contractor of the installation:

Storey/room:

Name of the system:

### Installation of hot and cold water and its circulation

Test pressure  $P_{op} = P_{proj} \times 1,1$  [bar]

### Heating, cooling water and surface heating/cooling installation.

Test pressure  $P_{op} = P_{work} + 2$  [bar] but not less than 4 bar

$P_{op}$  - pressure at which the tightness test is performed

$P_{proj}$  - maximum allowable pressure for the installation system

$P_{work}$  - system design pressure

Prior to the tightness test, diaphragm expansion vessels, fittings which may interfere with the test (e.g. differential pressure regulators, safety valves and any other installation components with an allowable working pressure lower than the test pressure must be disconnected).

The installation must be thoroughly flushed, filled with clean medium and vented before the test. The temperature of the medium should be stabilised in relation to the ambient temperature. For the test, use a disc manometer with a measuring range 50% greater than the test pressure and a measuring range of 0.1 bar. Connect the manometer at the geometrically lowest point of the system.

The ambient temperature should not change during the test.

Perform The tightness test in 3 steps:

#### PRELIMINARY TEST WITH REDUCED PRESSURE

Test pressure	Preliminary test conditions	Conditions of acceptance:
1.0 to 4.0 bar	- time to visually check all connections - keep the test pressure constant level	No moisture or leakage <input type="checkbox"/>

#### PRELIMINARY TEST

Preliminary test pressure:	Duration of the test	Conditions of acceptance:
$P_{op} = \dots\dots\dots$	30 min (Maintain the test pressure within this period, equalize if necessary). After 30 minutes, reduce the pressure to the value 0.5 times the test pressure	No moisture or leakage <input type="checkbox"/>

#### MAIN TEST

Main test pressure	Main test duration:	Conditions of acceptance:
$P_{op} \times 0,5$	30 min	No moisture or leakage <input type="checkbox"/> No pressure drop <input type="checkbox"/>

#### SUMMARY:

Ambient temperature:	Main test - duration	Pressure drop:
<input type="text"/>	<input type="text"/>	<input type="text"/>

Test result: POSITIVE  NEGATIVE

..... Date of test ..... Ordering party signature ..... Contractor signature .....

The procedure for carrying out a leak test on the system has been developed on the basis of standard EN 806-4 and own experience.

[www.kan-therm.com](http://www.kan-therm.com)

## 8.2 Screed heating protocol



# PROTOCOL

KAN-therm System  
surface heating/cooling  
screed heating

Investor:

Investment/address:

Installation contractor:

Storey/room:

Total area:

KAN-therm assembly system:

Screed type:

Thickness [mm]:

Supplement applied to screed:

Completion date of screed laying:

Remarks:

Heating screed (gypsum or cement) in accordance with EN 1264 standard must be done prior to the floor covering arrangement. In case of cement screed, heating can be executed after 21 days at the earliest, in case of gypsum, 7 days after the completion of screed laying. For the first 3 days the supply temperature should be maintained at 25 °C. For the 4 subsequent days, it should be heated with the maximum permissible supply temperature.

In case of custom screeds, the heating should be performed in accordance with manufacturer's instructions.

After the heating process, screed humidity test should be executed, which shall confirm whether the screed is ready for floor covering laying.

### SCREED HEATING COURSE

	DAY	DATE	TIME	TEMPERATURE	REMARKS
A	1				heating with a constant temperature 25 °C
	2				
	3				
B	1				heating with a maximum permissible installation supply temperature (3 days after <b>A</b> at the earliest)
	2				
	3				
	4				
C					completion of heating (4 days after <b>B</b> at the earliest)

Heating of screed was performed without interference

YES

NO

intervals from

to

Place and date

Ordering party signature

Contractor signature

[www.kan-therm.com](http://www.kan-therm.com)

## 8.3 Hydraulic adjustment execution protocol



# PROTOCOL

Tightness test of  
KAN-therm systems  
Medium: compressed air

Investor:

Investment/address:

Contractor of the installation:

Storey/room:

Name of the system:

All pipes should be sealed with metal plugs, caps, inserts, plastic plugs or blind flanges. Appliances, pressure vessels and water heaters must be disconnected from the pipes. A visual inspection should be carried out to check that the installation has been carried out correctly. The air used for the test must be oil-free. In the case of the KAN-therm Steel system, the compressed air must also be free of moisture. The ambient temperature of the installation under test must remain constant (max. ±3 °C). Any leaks detected can be located acoustically or visually, using a foaming agent approved by KAN Technical Support Department. For a leak test at a pressure of 110 mbar (0.11 bar) for a pipe volume of 100 l, the test duration is at least 30 minutes. For every additional 100 l of system capacity, the test duration must be extended by 10 minutes. The pressure gauge must allow for effective verification of the pressure at 110 mbar. Subsequently, a load test must be carried out at an elevated pressure, not exceeding 3 bar (0.3 MPa).

Pipes capacity ..... L                      Duration time ..... min

**TIGHTNESS TEST**

Test pressure	Duration time:	Were leaks located during the visual inspection?	Did the test reveal pressure change?
110 mbar (0,11 bar)	30 minutes (up to a capacity of 100 litres; for every additional 100 litres, extend the test time by 10 minutes)	YES <input type="checkbox"/> NO <input type="checkbox"/>	YES <input type="checkbox"/> NO <input type="checkbox"/>

**LOAD TEST WITH INCREASED PRESSURE**

Test pressure	Duration time	Did the test reveal pressure drop?
≤DN50 maximum 3 bar <input type="checkbox"/>	10 min	YES <input type="checkbox"/> NO <input type="checkbox"/>
>DN50 maximum 1,5 bar <input type="checkbox"/>		

**SUMMARY:**

Date of test:                       Ambient temperature:

Test result:                      POSITIVE                       NEGATIVE

Date of test
Ordering party signature
Contractor signature

[www.kan-therm.com](http://www.kan-therm.com)



All of the forms are available for download on KAN's website in 'download' section.

# 9 Mollier graph

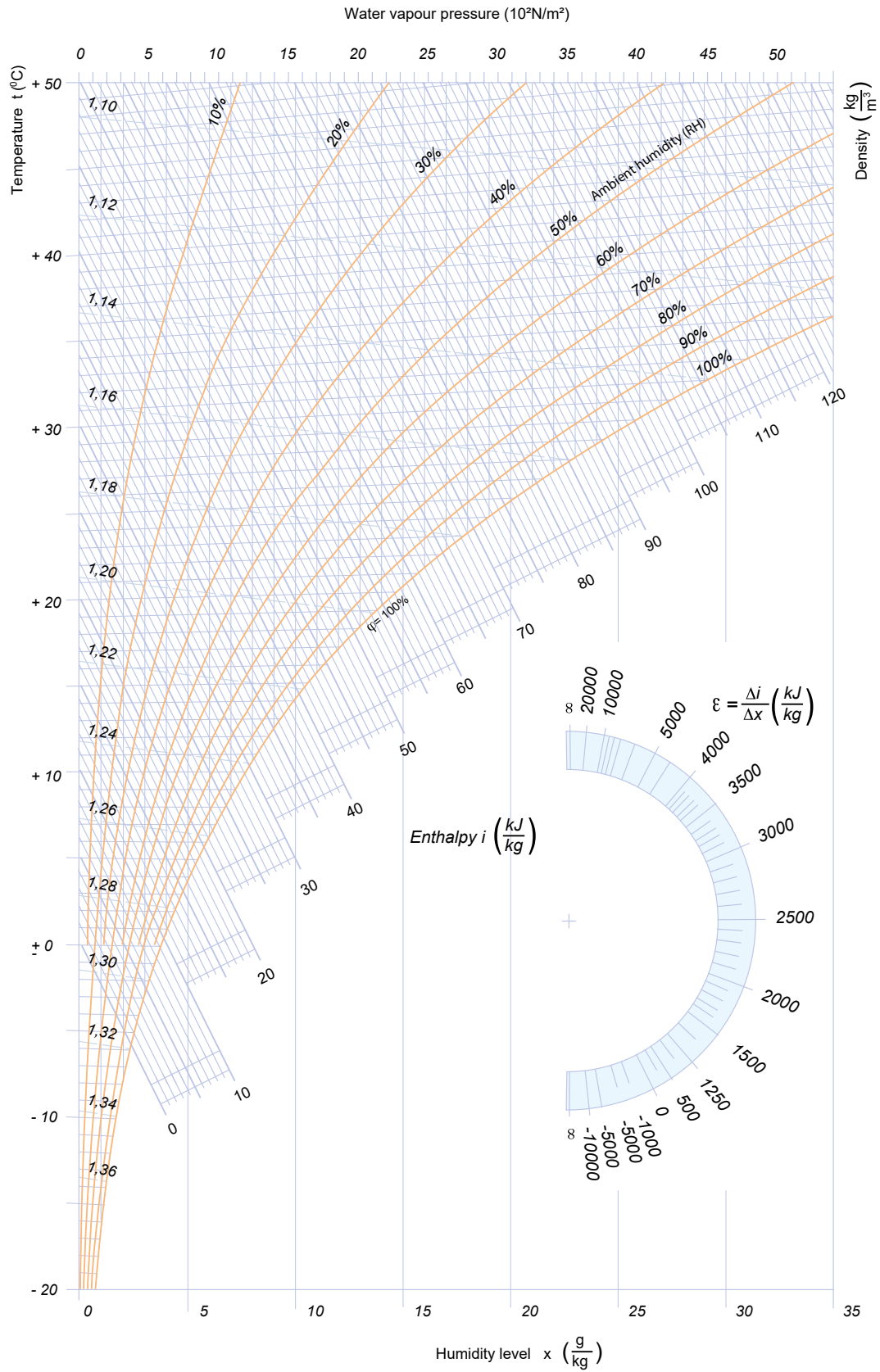











Kompletny multisystem instalacyjny, na który składają się najnowocześniejsze, wzajemnie uzupełniające się rozwiązania w zakresie rurowych instalacji wodnych, grzewczych, a także technologicznych i gaśniczych.

ultra**LINE**

ultra**PRESS**

**PP**

**Steel**

**Inox**

**Copper, Copper Gas**

**XPress Sprinkler**

**Surface heating and cooling  
and automation**

**Football  
Stadium installations**

**Cabinets  
and manifolds**

